

User's Manual

GSW-1602SF
GSW-2404SF
GSW-2416SF

10/100/1000Mbps
16/24-Port Web Smart
Gigabit Ethernet Switch



Trademarks

Copyright © PLANET Technology Corp. 2008.

Contents subject to which revision without prior notice.

PLANET is a registered trademark of PLANET Technology Corp. All other trademarks belong to their respective owners.

Disclaimer

PLANET Technology does not warrant that the hardware will work properly in all environments and applications, and makes no warranty and representation, either implied or expressed, with respect to the quality, performance, merchantability, or fitness for a particular purpose.

PLANET has made every effort to ensure that this User's Manual is accurate; PLANET disclaims liability for any inaccuracies or omissions that may have occurred.

Information in this User's Manual is subject to change without notice and does not represent a commitment on the part of PLANET. PLANET assumes no responsibility for any inaccuracies that may be contained in this User's Manual. PLANET makes no commitment to update or keep current the information in this User's Manual, and reserves the right to make improvements to this User's Manual and/or to the products described in this User's Manual, at any time without notice.

If you find information in this manual that is incorrect, misleading, or incomplete, we would appreciate your comments and suggestions.

FCC Warning

This equipment has been tested and found to comply with the limits for a Class A digital device, pursuant to Part 15 of the FCC Rules. These limits are designed to provide reasonable protection against harmful interference when the equipment is operated in a commercial environment. This equipment generates, uses, and can radiate radio frequency energy and, if not installed and used in accordance with the Instruction manual, may cause harmful interference to radio communications. Operation of this equipment in a residential area is likely to cause harmful interference in which case the user will be required to correct the interference at whose own expense.

CE Mark Warning

This is a Class A product. In a domestic environment, this product may cause radio interference, in which case the user may be required to take adequate measures.

WEEE Warning



To avoid the potential effects on the environment and human health as a result of the presence of hazardous substances in electrical and electronic equipment, end users of electrical and electronic equipment should understand the meaning of the crossed-out wheeled bin symbol. Do not dispose of WEEE as unsorted municipal waste and have to collect such WEEE separately.

Revision

PLANET Web Smart Gigabit Ethernet Switch User's Manual

FOR MODELS: GSW-1602SF/GSW-2404SF/GSW-2416SF

REVISION: 1.2 (JANUARY.2008)

Part No.: 2080-A82070-002

TABLE OF CONTENTS

1. INTRODUCTION.....	1
1.1 PACKAGE CONTENTS	1
1.2 HOW TO USE THIS MANUAL	1
1.3 PRODUCT FEATURES	1
1.4 PRODUCT SPECIFICATION	3
2. INSTALLATION.....	4
2.1 PRODUCT DESCRIPTION	4
2.1.1 Product Overview.....	4
2.1.2 GSW-1602SF/GSW-2404SF/GSW-2416SF Front Panel.....	4
2.1.3 LED Indicators.....	5
2.1.4 GSW-1602SF/GSW-2404SF/GSW-2416SF Rear Panel	6
2.2 INSTALL THE GSW-1602SF/2404SF/2416SF	7
2.2.1 Desktop Installation.....	7
2.2.2 Rack Mounting	7
2.2.3 Installing the SFP transceiver.....	8
3. SWITCH MANAGEMENT	10
3.1 OVERVIEW	10
3.2 MANAGEMENT METHODS.....	10
3.2.1 Web Management.....	10
3.2.2 Login the Switch.....	11
4. CONFIGURATION.....	12
4.1 MAIN MENU	12
4.2 SYSTEM.....	13
4.2.1 System Info	13
4.2.2 Misc Configuration	14
4.3 PORT CONFIGURATION.....	16
4.4 PORT MIRRORING.....	18
4.5 STORM CONTROL	19
4.6 VLANs	20
4.6.1 VLAN Membership.....	21
4.6.2 Per Port Configuration.....	23
4.6.3 VLAN setting example:.....	25
4.7 RAPID SPANNING TREE	32
4.7.1 RSTP System Configuration	33
4.7.2 RSTP Port Configuration.....	34
4.7.3 RSTP Status	35
4.8 LINK AGGREGATION	39
4.8.1 Port Trunk	39
4.8.2 LACP	40
4.8.3 LACP Status.....	42
4.9 IGMP SNOOPING	45

4.9.1 IGMP Snooping Configuration.....	45
4.9.2 IGMP Snooping Status.....	46
4.9.3 Multicast Group Table	48
4.10 QUALITY OF SERVICE	49
4.10.1 802.1p QoS Mode	50
4.10.2 DSCP QoS Mode	52
4.11 802.1X MANAGEMENT	53
4.11.1 RADIUS Server Configuration.....	54
4.11.2 Port Access Control	56
4.12 FILTER CONFIGURATION	58
4.13 MAC ADDRESSES	59
4.13.1 Dynamic Address Table	59
4.13.2 Static MAC Address	60
4.14 TOOLS.....	61
4.14.1 Reboot	61
4.14.2 Factory Reset.....	61
4.14.3 Firmware Upgrade	62
4.14.4 Configuration Upload	64
4.14.5 Ping	66
4.14.6 Cable Diagnostics	67
4.14.7 Web Smart Function	69
4.15 STATUS	71
4.15.1 Port Statistics	71
4.15.2 LACP Status.....	72
4.15.3 RSTP Status	72
4.15.4 IGMP Snooping Status.....	72
4.15.5 Multicast Group Status.....	72
5. SWITCH OPERATION.....	74
5.1 ADDRESS TABLE.....	74
5.2 LEARNING	74
5.3 FORWARDING & FILTERING	74
5.4 STORE-AND-FORWARD.....	74
5.5 AUTO-NEGOTIATION.....	74
5.6 IGMP SNOOPING	75
6. TROUBLESHOOTING.....	77
APPENDIX A	78
A.1 SWITCH'S RJ-45 PIN ASSIGNMENTS	78
A.2 10/100Mbps, 10/100BASE-TX	78
A.3 RJ-45 CABLE PIN ASSIGNMENT	78
A.4 AVAILABLE MODULES.....	79

1. INTRODUCTION

1.1 Package Contents

Check the contents of your package for following parts:

- Web Smart Gigabit Ethernet Switch x1
- CD-ROM user's manual x1
- Quick installation guide x1
- 19" rack mounting kit x1
- Power cord x1
- Rubber feet x 4

If any of these are missing or damaged, please contact your dealer immediately, if possible, retain the carton including the original packing material, and use them against to repack the product in case there is a need to return it to us for repair.

1.2 How to Use This Manual

This Web Smart Gigabit Ethernet Switch User Manual is structured as follows:

▪ Section 2, **Installation**

It explains the functions of GSW-1602SF/GSW-2404SF/GSW-2416SF and how to physically install the GSW-1602SF/GSW-2404SF/GSW-2416SF.

▪ Section 3, **Switch Management**

It contains information about the managed methods of GSW-1602SF/GSW-2404SF/GSW-2416SF.

▪ Section 4, **Configuration**

It contains information about the Smart function of GSW-1602SF/GSW-2404SF/GSW-2416SF.

Section 5, **Switch operation**

It contains Switch operation information of GSW-1602SF/GSW-2404SF/GSW-2416SF.

Section 6, **Troubleshooting**

It contains Troubleshooting information of GSW-1602SF/GSW-2404SF/GSW-2416SF.

Appendix A

It contains cable information of GSW-1602SF/GSW-2404SF/GSW-2416SF.

1.3 Product Features

■ **Generic Features**

- Complies with IEEE 802.3, 10Base-T, IEEE 802.3u, 100Base-TX, IEEE 802.3ab, 1000Base-T, IEEE 802.3z, 1000Base-SX/LX, Ethernet standard
- 16/24-Port 10/100/1000Mbps Gigabit Ethernet ports
- 2/4/16-Port SFP (Small Form-factor Pluggable) for 3.3V mini GBIC module,

- GSW-1602SF - shared with Port-15 and Port-16.
 - GSW-2404SF - shared with Port-21 to Port 24.
 - GSW-2416SF - shared with Port-1 to Port-8, Port-17 to Port-24
- Each Switching ports support auto-negotiation-10/20Mbps, 100/200Mbps and 1000/2000Mbps supported
- Auto-MDI/MDI-X detection on each RJ-45 port, support CSMA/CD protocol
- Prevents packet loss with back pressure (Half-Duplex) and IEEE 802.3x PAUSE frame flow control (Full-Duplex)
- High performance Store and Forward architecture, broadcast storm control, runt/CRC filtering eliminates erroneous packets to optimize the network bandwidth
- 8K MAC address table, automatic source address learning and ageing
- 32/48Gbps switch fabric, non-blocking switch architecture
- 9K Jumbo Frame support at all speed (10/100/1000Mbps)
- **Layer-2 Switching**
 - Support Port-based and IEEE 802.1Q VLAN function, up to 64 VLAN groups
 - IEEE 802.1w Rapid-Spanning Tree protocol support
 - Link Aggregation support static mode and LACP (IEEE 802.3ad) - up to 8 Trunk groups, each trunk for up to maximum 12 ports
 - IGMP Snooping v1/v2 – multicast filtering
- **Quality of Service**
 - 4 QoS classes per port
 - Traffic class assignment based on IEEE 802.1p tag, or DSCP field
 - Multicast and Broadcast Storm Control as well as Flooding Control
 - Rate Limit bandwidth control at both inband and outband in steps of 128kbps
- **Security**
 - Port Mirroring support for dedicated port monitoring
 - IEEE 802.1X Port-Base access control, RADIUS ServerAuthentication
 - Source IP filter per port to block unwanted access
 - Static MAC Address assign destination MAC address at specifies port.
- **Management**
 - Remote Web management interface
 - Firmware upgrade through Web interface
 - Cable Diagnostics technology
 - Support SNMPv1 with RFC-1213/1573-Interface group, Ethernet MIB
 - SNMP Trap

1.4 PRODUCT SPECIFICATION

Model	GSW-1602SF	GSW-2404SF	GSW-2416SF
Hardware Specification			
Network ports	16	24	24
SFP/mini-GBIC slot	2	4	16
Switch architecture	Store-and-Forward		
Switch Fabric	32Gbps	48Gbps	
Switch throughput	23.8Mpps	35.7Mpps	
Address Table	8K entries		
Share data Buffer	340KB	500KB	
Flow Control	Back pressure for half duplex, IEEE 802.3x Pause Frame for full duplex		
Dimensions (mm)	440 x 210 x 44 (1U height)		440 x 220 x 44
Weight	2kg	2kg	2.6 kg
Power Requirement	100-240V AC, 50-60 Hz		
Power Consumption	30 watts, 102BTU		60 watts, 190BTU
Standards Conformance			
Network Standards	IEEE 802.3 (Ethernet), IEEE 802.3u (Fast Ethernet) IEEE 802.3ab (Gigabit Ethernet) IEEE 802.3z (Gigabit Ethernet, 1000Base-SX/LX) IEEE 802.1Q (Tagged VLAN) IEEE 802.1w (Rapid Spanning Tree) IEEE 802.1X (Port-Based Authentication) IEEE 802.3ad (Link Aggregation Control Protocol) IEEE 802.3x (Full-duplex flow control)		
Operating Temperature	0~50°C		
Storage Temperature	-40~70°C		
Operating Humidity	5% to 90% , relative humidity, non-condensing		
Storage Humidity	5% to 90% , relative humidity, non-condensing		
Regulation Compliance	FCC Part 15 Class A, CE		

2. INSTALLATION

This section describes the functionalities of GSW-1602SF/GSW-2404SF/GSW-2416SF's components and guides how to install it on the desktop or shelf. Basic knowledge of networking is assumed. Please read this chapter completely before continuing.

2.1 Product Description

The PLANET GSW-1602SF/GSW-2404SF/GSW-2416SF is a 16/24-Port 10/100/1000Mbps Web Smart Gigabit Ethernet Switch with non-blocking wire-speed performance. With 32/48Gbps internal switching fabric, the GSW-1602SF/GSW-2404SF/GSW-2416SF can handle extremely large amounts of data transmission in a secure topology linking to a backbone or high-power servers. The GSW-1602SF /GSW-2404SF /GSW-2416SF could recognize up to 8K MAC Address table and provides 340KB /500KB on-chip frame buffer. The GSW-1602SF /GSW-2404SF /GSW-2416SF offers wire-speed packet transfer performance without risk of packet loss. The high data throughput, it can provide the most convenient for user to upgrade their network to Gigabit environment.

2.1.1 Product Overview

PLANET GSW-1602SF/GSW-2404SF/GSW-2416SF is a Web Smart Gigabit Ethernet Switch with 16/24 RJ-45 10/100/1000Mbps ports for high-speed network connectivity. The GSW-1602SF/GSW-2404SF/GSW-2416SF can also automatically identify and determine the correct transmission speed and half/full duplex mode of the attached devices with its 16/24 ports. The Gigabit port can handle large amounts of data transmission in a secure topology linking to a backbone or high-power servers.

These products also supports store-and-forward forwarding scheme to ensure low latency and high data integrity, eliminates unnecessary traffic and relieves congestion on critical network paths. With an intelligent address recognition algorithm, GSW-1602SF/GSW-2404SF/GSW-2416SF could recognize up to 8K different MAC address and enables filtering and forwarding at full wire speed.

2.1.2 GSW-1602SF/GSW-2404SF/GSW-2416SF Front Panel

Figure 2-1 & 2-2 & 2-3 shows a front panel of GSW-1602SF/GSW-2404SF/GSW-2416SF.

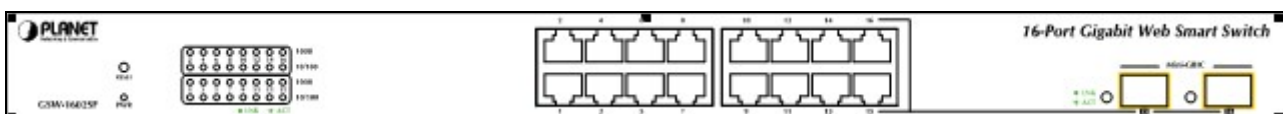

Figure 2-1 PLANET GSW-1602SF Front Panel

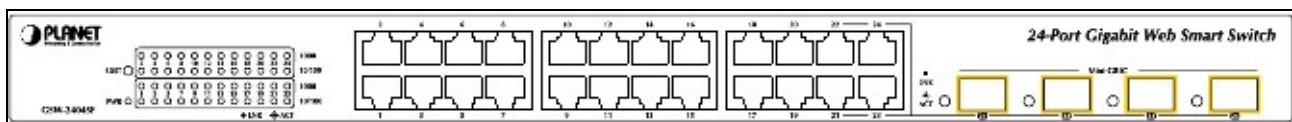

Figure 2-2 PLANET GSW-2404SF Front Panel

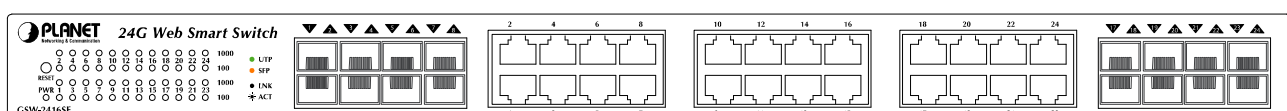

Figure 2-3 PLANET GSW-2416SF Front Panel

2.1.3 LED Indicators

■ LED of GSW-1602SF / GSW-2404SF

LED	Color	Function
PWR	Green	Lights to indicate that the Switch is powered on.
1000 LNK/ACT	Green	Lights to indicate that the Switch is successfully connecting to the network at 1000Mbps. Blinks to indicate the Switch is receiving or sending data.
10/100 LNK/ACT	Green	Lights to indicate that the Switch is successfully connecting to the network at 10/100Mbps. Blinks to indicate the Switch is receiving or sending data.
SFP LNK/ACT	Green	Lights to indicate that the Switch is successfully connecting to the network at 1000Mbps through SFP interface. Blinks to indicate the Switch is receiving or sending data.

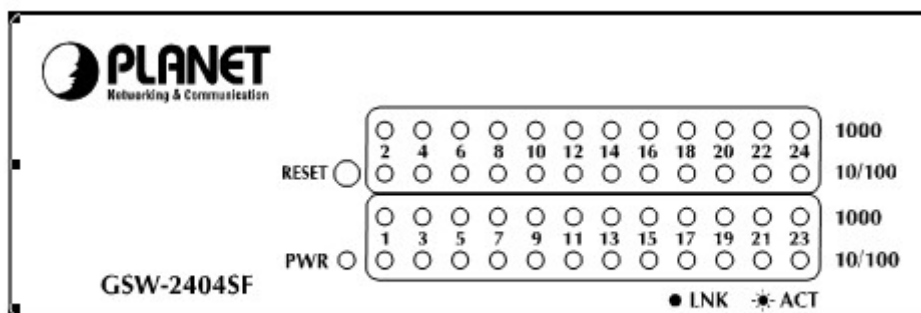

Figure 2-4 PLANET GSW-2404SF LED panel

■ LED of GSW-2416SF

➤ SFP interfaces

LED	Color	Function
SFP LNK/ACT	Orange	Lights to indicate that the Switch is successfully connecting to the network at 1000Mbps through SFP interface. Blinks to indicate the Switch is receiving or sending data.

➤ 10/100/1000Base-T Ports

LED	Color	Function
1000 LNK/ACT	Green	Lights to indicate that the Switch is successfully connecting to the network at 1000Mbps. Blinks to indicate the Switch is receiving or sending data.
100 LNK/ACT	Green	Lights to indicate that the Switch is successfully connecting to the network at 100Mbps. Blinks to indicate the Switch is receiving or sending data.

Remark: For port 1 to port 8 and port 17 to port 24, either SFP or TP can be used at one time. SFP will be higher priority

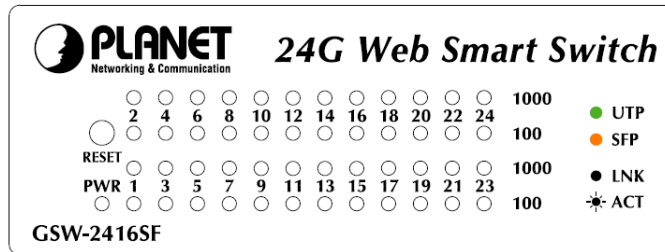

Figure 2-5 PLANET GSW-2416SF LED panel

Note: To press 5 seconds and release the RESET button. The GSW-1602SF/GSW-2404SF /GSW-2416SF will back to the factory default mode. Be sure that you backup the current configuration of GSW-1602SF/GSW-2404SF/GSW-2416SF; else the entire configuration will be erased when pressing the “RESET” button.

2.1.4 GSW-1602SF/GSW-2404SF/GSW-2416SF Rear Panel

The rear panel of the Switch indicates an AC inlet power socket, which accepts input power from 100 to 240V AC, 50-60Hz.

■ GSW-1602SF / GSW-2404SF

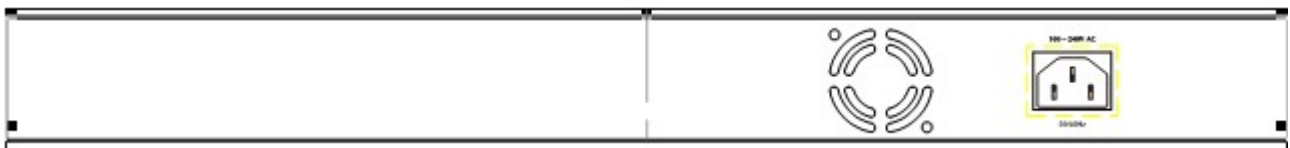

Figure 2-6 Rear Panel of GSW-1602SF/GSW-2404SF

■ GSW-2416SF

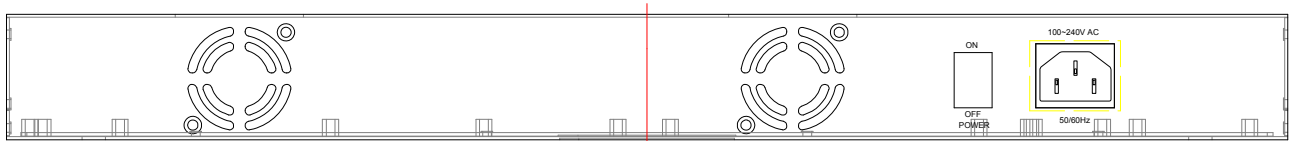

Figure 2-7 Rear Panel of GSW-2416SF

Power Notice:

1. The device is a power-required device, it means, it will not work till it is powered. If your networks should active all the time, please consider using **UPS** (Uninterrupted Power Supply) for your device. It will prevent you from network data loss or network downtime.
2. In some area, installing a surge suppression device may also help to protect your Switch from being damaged by unregulated surge or current to the Switch or the power adapter.

2.2 Install the GSW-1602SF/2404SF/2416SF

This section describes how to install your GSW-1602SF/GSW-2404SF/GSW-2416SF Web Smart Gigabit Ethernet Switch and make connections to the Switch. Please read the following topics and perform the procedures in the order being presented. PLANET GSW-1602SF/GSW-2404SF/GSW-2416SF Web Smart Gigabit Ethernet Switch do not need software configuration. To install your GSW-1602SF/GSW-2404SF/GSW-2416SF on a desktop or shelf, simply complete the following steps.

2.2.1 Desktop Installation

To install a GSW-1602SF/GSW-2404SF/GSW-2416SF on a desktop or shelf, simply complete the following steps:

Step1: Attach the rubber feet to the recessed areas on the bottom of the Switch.

Step2: Place the GSW-1602SF/GSW-2404SF/GSW-2416SF on a desktop or shelf near an AC power source.

Step3: Keep enough ventilation space between the Switch and the surrounding objects.

 **Note:** When choosing a location, please keep in mind the environmental restrictions discussed in Chapter 1, Section 4, and Specification.

Step4: Connect your GSW-1602SF/GSW-2404SF/GSW-2416SF to network devices.

- A. Connect one end of a standard network cable to the 10/100/1000 RJ-45 ports on the front of the GSW-1602SF/GSW-2404SF/GSW-2416SF
- B. Connect the other end of the cable to the network devices such as printer servers, workstations or routers...etc.

 **Note:** Connection to the Switch requires UTP Category 5 network cabling with RJ-45 tips. For more information, please see the Cabling Specification in Appendix A.

Step5: Supply power to the Switch.

- A. Connect one end of the power cable to the GSW-1602SF/GSW-2404SF/GSW-2416SF.
- B. Connect the power plug of the power cable to a standard wall outlet.

When the GSW-1602SF/GSW-2404SF/GSW-2416SF receives power, the Power LED should remain solid Green.

2.2.2 Rack Mounting

To install the switch in a **19-inch** standard rack, follow the instructions described below.

Step1: Place your GSW-1602SF/GSW-2404SF/GSW-2416SF on a hard flat surface, with the front panel positioned towards your front side.

Step2: Attach a rack-mount bracket to each side of the Switch with supplied screws attached to the package. Figure 2-8 shows how to attach brackets to one side of the Switch.

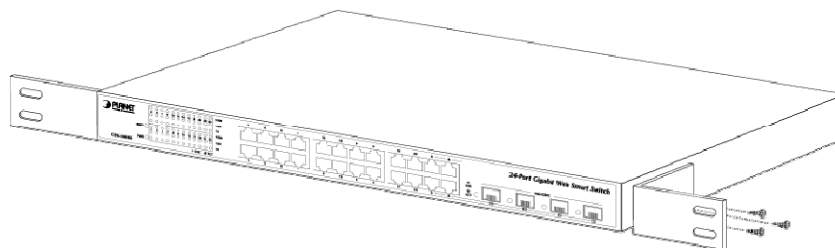

Figure 2-8 Attaching the brackets to the Switch

Caution: You must use the screws supplied with the mounting brackets. Damage caused to the parts by using incorrect screws would invalidate your warranty.

Step3: Secure the brackets tightly.

Step4: Follow the same steps to attach the second bracket to the opposite side.

Step5: After the brackets are attached to the Switch, use suitable screws to securely attach the brackets to the rack, as shown in Figure 2-9

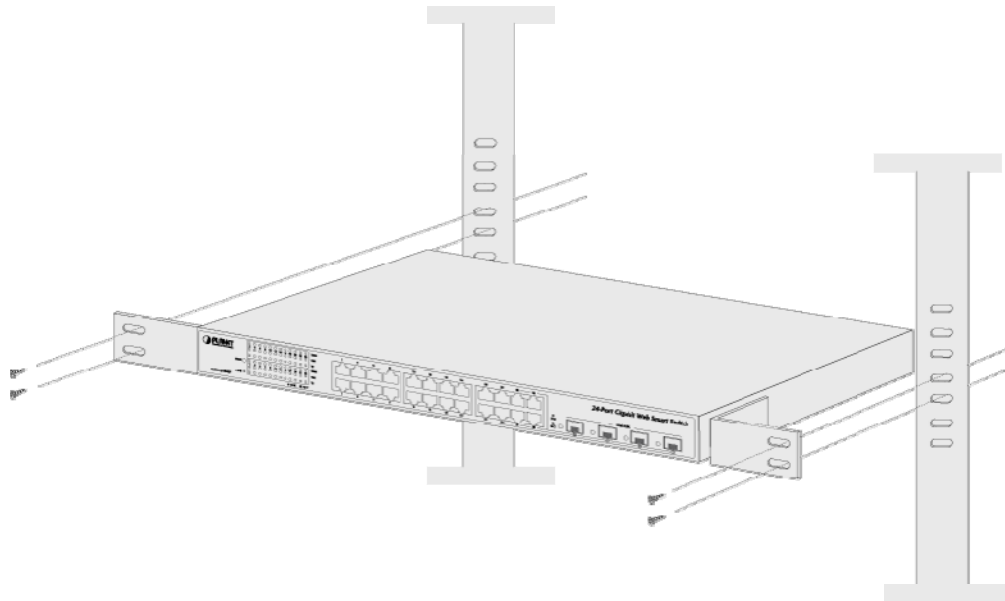

Figure 2-9 Mounting the Switch in a Rack

Step6: Precede with the steps 4 and steps 5 of session **2.2.1 Desktop Installation** to connect the network cabling and supply power to your switch.

2.2.3 Installing the SFP transceiver

The sections describe how to insert an SFP transceiver into an SFP slot.

The SFP transceivers are hot-plug e and hot-swappable. You can plug-in and out the transceiver to/from any SFP port without having to power down the Switch. As the Figure 2-10 appears.

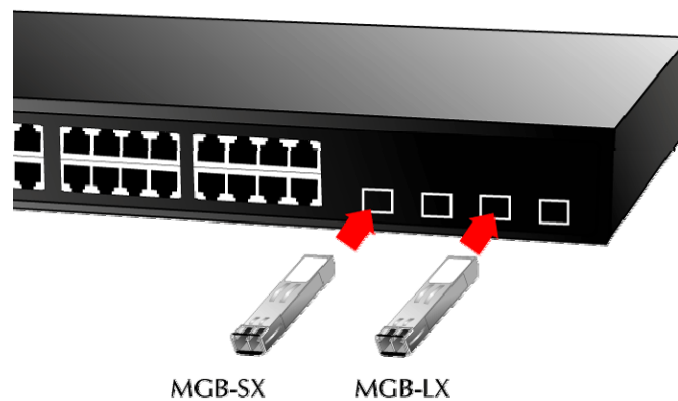

Figure 2-10 Plug-in the SFP transceiver

Approved PLANET SFP Transceivers

PLANET GSW-1602SF/GSW-2404SF/GSW-2416SF support both single mode and multi mode SFP transceiver. The following list of approved PLANET SFP transceivers is correct at the time of publication:

- MGB-SX SFP (1000BASE-SX SFP transceiver)
- MGB-LX SFP (1000BASE-LX SFP transceiver)



Note:

It recommends using PLANET SFPs on the Switch. If you insert a SFP transceiver that is not supported, the Switch will not recognize it.

Before connect the other switches, workstation or Media Converter.

1. Make sure both side of the SFP transfer are with the same media type, for example: 1000Base-SX to 1000Base-SX, 1000Bas-LX to 1000Base-LX.
2. Check the fiber-optic cable type match the SFP transfer model.
 - To connect to **1000Base-SX** SFP transceiver, use the **multi-mode** fiber cable- with one side must be male duplex LC connector type.
 - To connect to **1000Base-LX** SFP transceiver, use the **single-mode** fiber cable-with one side must be male duplex LC connector type.

Connect the fiber cable

1. Attach the duplex LC connector on the network cable into the SFP transceiver.
2. Connect the other end of the cable to a device – switches with SFP installed, fiber NIC on a workstation or a Media Converter..
3. Check the LNK/ACT LED of the SFP slot on the front of the Switch. Ensure that the SFP transceiver is operating correctly.
4. Check the Link mode of the SFP port if the link failed. Co works with some fiber-NICs or Media Converters, set the Link mode to “**1000 Force**” is needed.

3. SWITCH MANAGEMENT

This chapter describes how to manage the GSW-1602SF/GSW-2404SF/GSW-2416SF. Topics include:

- Overview
- Management methods
- Assigning an IP address to the GSW-1602SF/GSW-2404SF/GSW-2416SF
- Logging on to the GSW-1602SF/GSW-2404SF/GSW-2416SF

3.1 Overview

This chapter gives an overview of switch management. The GSW-1602SF/GSW-2404SF/GSW-2416SF provides a simply **Web browser interface**. Using this interface, you can perform various switch configuration and management activities, including:

- System
- Port Configuration
- Port Mirroring
- Storm Control
- VLANs
- Rapid Spanning Tree
- Link Aggregation
- IGMP Snooping
- Quality of Service
- 802.1X Management
- Filter Configuration
- MAC Address
- Tools
- Status

Please refer to the following Chapter 4 for more details.

3.2 Management Methods

The way to manage the GSW-1602SF/GSW-2404SF/GSW-2416SF:

- Web Management via a network connection.

3.2.1 Web Management

The PLANET Web-Smart Gigabit Ethernet Switch provides a built-in browser interface. You can manage the GSW-1602SF/GSW-2404SF/GSW-2416SF remotely by having a remote host with web browser, such as Microsoft Internet Explorer, Netscape Navigator or Mozilla Firefox.

Using this management method:

The GSW-1602SF/GSW-2404SF/GSW-2416SF must have an Internet Protocol (IP) address accessible for the remote host. The screen in **Figure 3-1** appears.

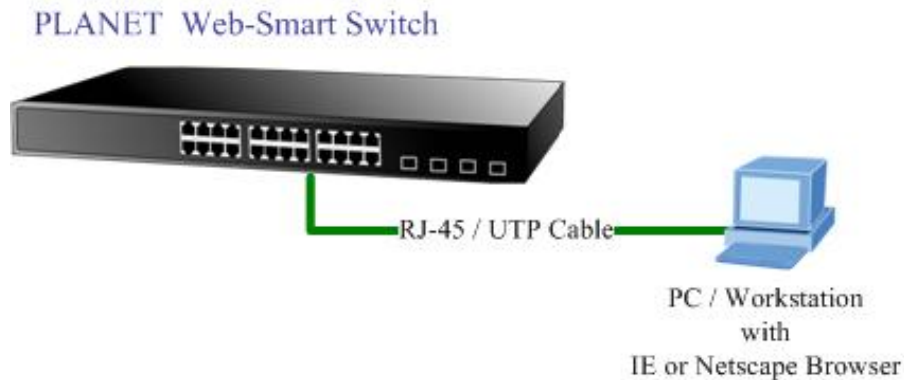

Figure 3-1 Web Management via ethernet

3.2.2 Login the Switch

Before you start configure the GSW-1602SF/GSW-2404SF/GSW-2416SF, please note the GSW-1602SF/GSW-2404SF/GSW-2416SF is configured through an Ethernet connection, make sure the manager PC must be set on same the **IP subnet address**. For example, the default IP address of the GSW-1602SF/GSW-2404SF/GSW-2416SF is **192.168.0.100**, then the manager PC should be set at 192.168.0.x (where x is a number between 2 and 254, except 100), and the default subnet mask is 255.255.255.0. Use Internet Explorer 5.0 or above Web browser. Enter IP address **http://192.168.0.100** (the factory-default IP address) to access the Web interface.

When the following login screen appears, please enter the default password "**admin**" and press Login to enter the main screen of GSW-1602SF/GSW-2404SF/GSW-2416SF. The login screen in **Figure 3-2** appears.

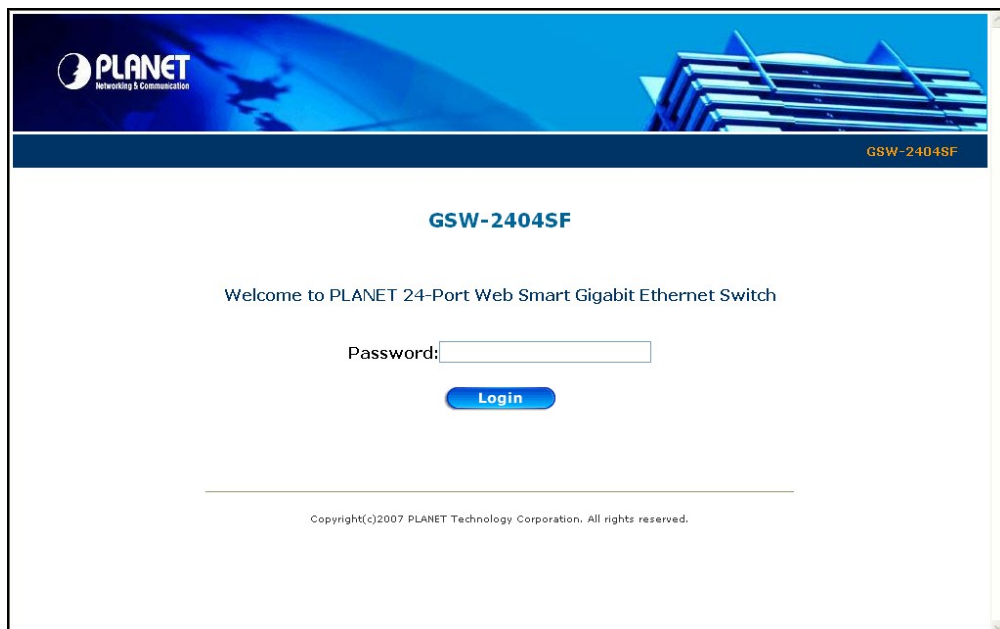

Figure 3-2 Login screen



Note:

1. For security reason, please change and memorize the new password after this first setup.
2. Only accept command in lowercase letter under Web interface.

4. CONFIGURATION

The GSW-1602SF/GSW-2404SF/GSW-2416SF Web Smart Gigabit Ethernet Switch provide Web interface for Switch smart function configuration and make the Switch operate more effectively - They can be configured through the Web Browser. A network administrator can manage and monitor the GSW-1602SF /GSW-2404SF/GSW-2416SF from the local LAN. This section indicates how to configure the Switch to enable its smart function.

Notice:

The following section will base on the console screens of GSW-2404SF, for GSW-1602SF and GSW-2416SF the display will be the same to GSW-2404SF.

4.1 Main Menu

After a successful login, the main screen appears, the main screen displays the Switch status. The screen in **Figure 4-1** appears.



Figure 4-1 Web Main screen

As listed at the left of the main screen, the configurable smart functions are shown as below:

- ◆ **System** – Check the hardware, software version and System MAC address. Setting the IP address and **SNMP** management for the switch. Explain in section 4.2
- ◆ **Port Configuration** – Setup per port Speed/Duplex mode, Flow Control and jumbo frame. Explain in section 4.3
- ◆ **Port Mirroring** – dedicated port monitoring for incoming packets. Explain in section 4.4
- ◆ **Storm Control** – various type of storm control value assign. Explain in section 4.5
- ◆ **VLANs** – Configure VLAN Member / Port Configuration. Explain in section 4.6
- ◆ **Rapid Spanning Tree** – Configure Rapid spanning tree topography for any arrangement of bridges . Explain in section 4.7
- ◆ **Link Aggregation** – Port Trunk / **LACP**. Explain in section 4.8
- ◆ **IGMP Snooping** – Enables or disables **IGMP** Snooping on the device to filter the multicast stream. Explain in section 4.9
- ◆ **Quality of Service** – Mapping the packet level to classify the packets priority. Explain in section 4.10
- ◆ **802.1X Management** – Specify ports with network access control. Explain in section 4.11
- ◆ **Filter Configuration** – per port traffic filter based on IP address. Explain in section 4.12

- ◆ **MAC Address** – Dynamic Address Table / Static MAC Address. Explain in section 4.13
- ◆ **Tools** – Reboot / Factory Reset / Firmware Update / Configuration Upload / Ping / Cable Diagnostic. Explain in section 4.14
- ◆ **Status** – Port Statistics Overview / Port Statistics Detail / **LACP** Status / **RSTP** Status / **IGMP** Snooping Status / Multicast Group Status. Explain in section 4.15

4.2 System

4.2.1 System Info

The System Info page provides information for the current device information. System Info page helps a switch manager to identify the versions and IP subnet Address etc. The screen in **Figure 4-2** appears.

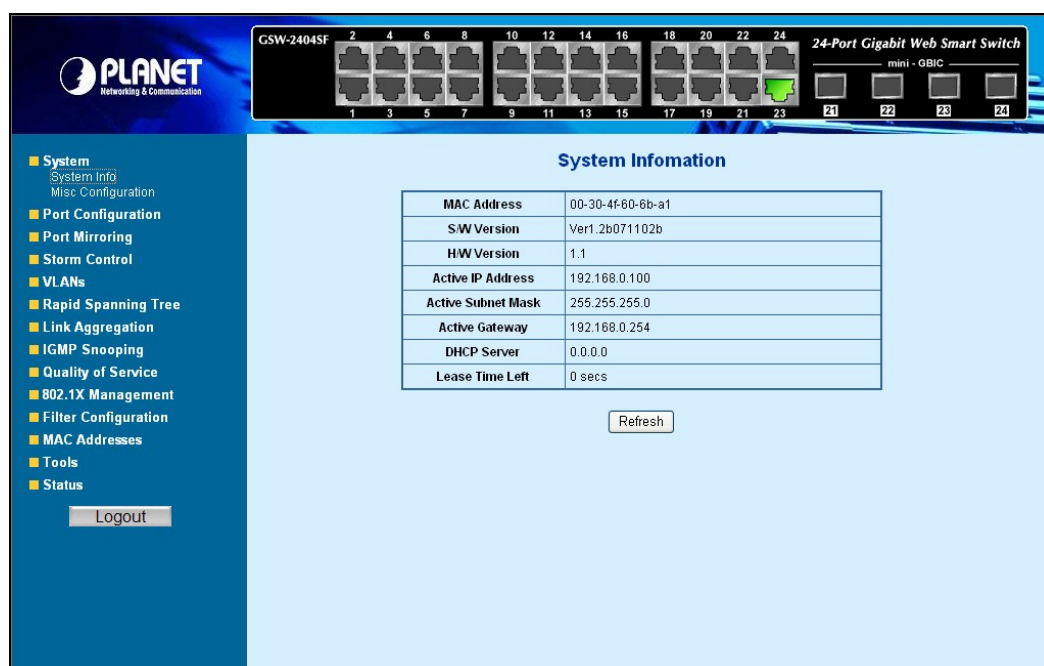

Figure 4-2 System Information screen

The page includes the following fields; see the **table 4-1** description of the system information.

Item	Description
• MAC Address	Specifies the device MAC address.
• S/W Version	The current software version running on the device.
• H/W Version	The current hardware version of the device
• Active IP Address	The current IP Address of the device. The IP Address could be manual assigned or get via DHCP server.
• Active Subnet Mask	The current IP Subnet Mask setting on the device.
• Active Gateway	The current Gateway of the device.
• DHCP Server	If the IP address is got and assigned via a DHCP server, the field shows the IP Address of the DHCP server.
• Lease Time left	If the IP address of the device be assigned via a DHCP Server, a DHCP lease time would be apply to the device too. The lease time left shows the left time if the device didn't request the IP Address to the DHCP server, then the IP address will be released.

Table 4-1 Description of the system information

4.2.2 Misc Configuration

The Misc Configuration includes the DHCP Enabled, IP Subnet address, Power Saving and Management VLAN. System name and description, password, Inactivity Timeout and SNMP enable and SNMP related function. The screen in **Figure 4-3** appears.

The screenshot shows the 'Misc Configuration' page for a Planet GSW-2404SF switch. The page features a navigation sidebar on the left and a main configuration area. The configuration area contains the following fields:

Field	Value
DHCP Enabled	Disable
IP Address	192.168.100.100
Subnet Mask	255.255.255.0
Gateway	192.168.100.1
Power Saving	Disable
Management VLAN	1
System Name	GSW-2404SF
System Description	GSW-2404SF
Password	•••••
Inactivity Timeout	300 (60~10000 secs 0: No limit)
SNMP enabled	<input checked="" type="checkbox"/>
SNMP Trap destination	0.0.0.0
SNMP Read Community	public
SNMP Write Community	
SNMP Trap Community	public

Buttons for 'Apply' and 'Refresh' are located at the bottom of the configuration area.

Figure 4-3 Misc Configuration screen

The page includes the following configurable data; see the **table 4-2** description of the Misc Configuration.

Item	Description
DHCP Enabled -	Choose what the switch should do following power-up: transmit a DHCP request, or manual setting (Disable). The factory default is “Disable” .
IP Address -	The IP address of the interface. The factory default value is 192.168.0.100
Subnet Mask -	The IP subnet mask for the interface. The factory default value is 255.255.255.0
Gateway -	The default gateway for the IP interface. The factory default value is 192.168.0.254
Power Saving	This function provide the device can operate under less power consumption mode and saves energy, money, and helps protect the environment. The available options are disable and enable, the default value is “Disable”
Management VLAN -	Specifies the management VLAN ID of the switch. It may be configured to any value in the range of 1 - 4093. The management VLAN is used for management of the Switch.
System Name –	Defines the user-defined device name

System Description	Defines the user-defined device description
Password -	This function provides administrator to secure Web login
Inactivity Timeout –	Specifies a time period for the user login. The web interface will be auto logout if there're no actions from the login user. The default value is 300 seconds; 0 means no inactivity time limit.
SNMP Enable –	Enable or Disable the SNMP function of the device. While set to enable, the manager could remotely get the interface status and received the traps information.
SNMP Trap destination –	The Trap function enables the Switch to monitor the Trap through the Web Switch Utility, set the Trap IP Address of the manager workstation where the trap to be sent
SNMP Read Community –	Functions as a password and used to authenticate the access right of the device. The Read Community is restricted to read-only, for all MIBs except the community table, for which there is no access.
SNMP write Community –	Functions as a password and used to authenticate the access right of the device. The Write Community accesses the device both read and write - configure to the device via SNMP .
SNMP Trap Community –	Identifies the community string of the trap manager

Table 4-2 Description of the Misc Configuration

 **Note:** After change the default password, if you forget the password. Please press 5 seconds and release the **“Reset”** button in the front panel of GSW-1602SF/GSW-2404SF/GSW-2416SF, the current setting includes VLAN, will be lost and the GSW-1602SF/GSW-2404SF/GSW-2416SF will restore to the default mode.

4.3 Port Configuration

This function allows displaying each port's status. The Link Status in the screen displays the current connection speed and duplex mode; else this function will show down when the port is disconnected. Press the **"Refresh"** button to renew the screen. The screen in **Figure 4-4** appears.

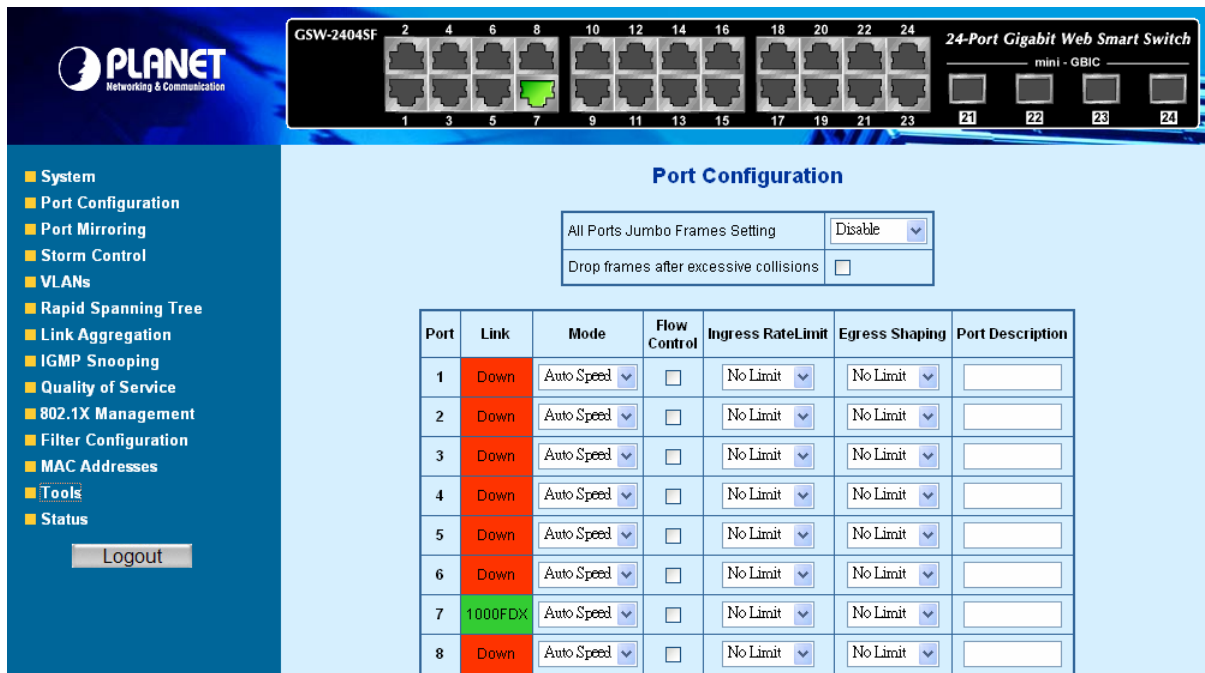



Figure 4-4 Port Configuration screen

The page includes the following configurable data; see the **table 4-3** description of the Port Configuration.

• Item	Description
• All Ports Jumbo Frames Setting	<p>The maximum Ethernet frame size the interface supports or is configured, including Ethernet header, CRC, and payload. Draw the menu bar to select the mode.</p> <ul style="list-style-type: none"> • Disable - The default maximum frame size is 1518 • 4096 Kbytes – Set the maximum frame size to 4096 Bytes • 9600 Kbytes - Set the maximum frame size to 9600 Bytes
• Drop frames after excessive collisions	<p>Enable or Disable the device to drop frames once the excessive collisions be detected.</p>
• Port	<p>Indicate port 1 to port 24.</p>
• Link	<p>Indicate current link status and link speed duplex mode of each port.</p>
• Mode	<p>Allow configuring the port speed and operation mode. Draw the menu bar to select the mode.</p> <ul style="list-style-type: none"> • Auto Speed - Setup Auto negotiation. • 10 half - Force sets 10Mbps/Half-Duplex mode. • 10 Full - Force sets 10Mbps/Full-Duplex mode. • 100 half - Force sets 100Mbps/Half-Duplex mode. • 100 full - Force sets 100Mbps/Full-Duplex mode. • 1000 full - Force sets 1000Mbps/Full-Duplex mode. • Disable - Shutdown the port manually.
• Flow Control	<p>Allow Enable or Disable flow control for selected port.</p> <ul style="list-style-type: none"> • Enable – 802.3x flow control is enabled on Full-Duplex mode or

	<p>Backpressure is enabled on Half-Duplex mode.</p> <ul style="list-style-type: none"> • Disable – No flow control or backpressure function on no matter Full-Duplex or Half-Duplex mode
• Ingress Rate Limit	<p>The value of inbound traffic limitation in kilobit-per-second (kbps). Per port in step of 128 kbps.</p> <p>Default : No Limit</p> <p>The range between 128 Kbps to 3968 kbps.</p>
• Egress Shaping	<p>The value of outbound traffic limitation in kilobit-per-second (kbps). Per port in step of 128 kbps.</p> <p>Default : No Limit</p> <p>The range between 128 Kbps to 3968 kbps.</p>
• Port Description	<p>Make a brief description for the port to help network manager identify the device connected to it.</p> <p>Maximum Length : 8 characters</p> <p>For example, label it as "<i>VoIP Phone</i>" if an VoIP Phone is connected to this port.</p>

Table 4-3 Description of the Port Configuration

 **Note:** When set each port to run at 100M Full, 100M Half, 10M Full, and 10M Half-speed modes. The Auto-MDIX function will disable.

4.4 Port Mirroring

This function provide to monitoring network traffic that forwards a copy of each incoming or outgoing packet from one port of a network Switch to another port where the packet can be studied. It enables the manager to keep close track of switch performance and alter it if necessary. The Port Mirroring screen in **Figure 4-5** appears.

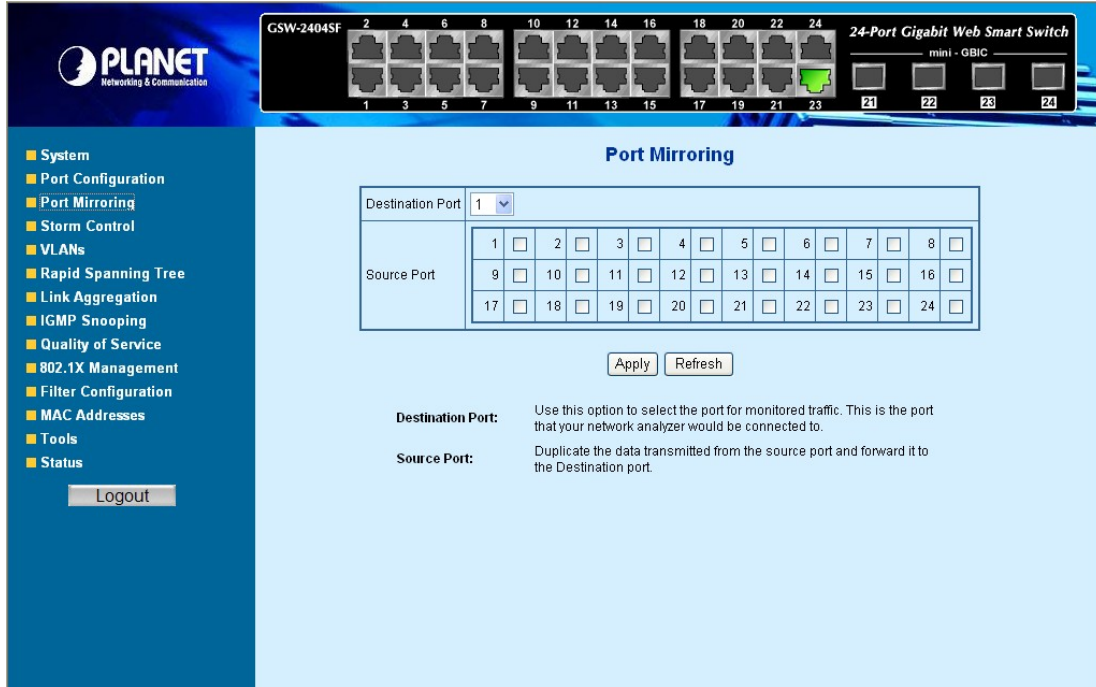

Figure 4-5 Mirror Setting screen

The page includes the following configurable data **table 4-4** description of the Port Mirroring.

• Item	Description
• Destination Port	Use this option to select the port for monitored traffic. This is the port that your network analyzer would be connected to – such as NAI Sniffer Pro or Ethereal .
• Source Port	Duplicate the data transmitted from the source port and forward it to the Destination port.

Table 4-4 Description of the Port Mirroring

Configuring the port mirroring by assigning a source port from which to copy all packets and a destination port where those packets will be sent.

Note: With the Chipset specification – the GSW-1602SF/GSW-2404SF/GSW-2416SF port mirroring support **RX (receive) mode only** - this mode will duplicate the data that send to the source and forward to the destination port.

4.5 Storm Control

This function provide various type of storm control of the device, such as ICMP Rate , Learn Frames Rate, Broadcast Rate, Multicast Rate and Flooded unicast Rate. The Storm Control screen in **Figure 4-6** appears.

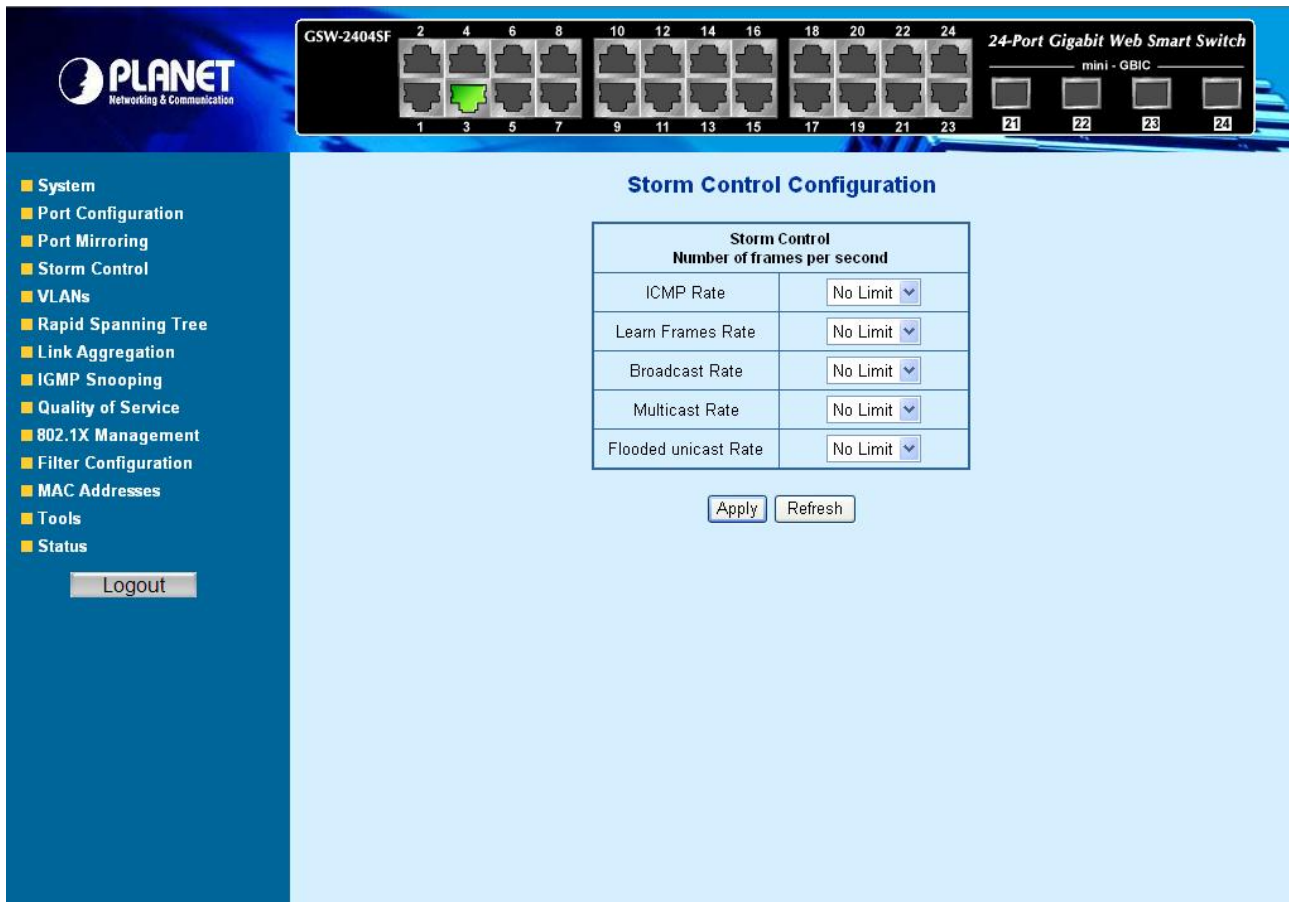

Figure 4-6 Storm Control screen

The page includes the following configurable data **table 4-5** description of the Storm Control.

• Item	Description
• ICMP Rate	This function allows to filter the ICMP storm traffic, the available options are 1K/2K/4K/8K/16K/32K/64K/128K/256K/512K/1024K/2048K/4096K/8192K/1638K4/32768K and “No Limit” .
• Learn Frames Rate	This function allows to filter the learn frames storm traffic, the available options are 1K/2K/4K/8K/16K/32K/64K/128K/256K/512K/1024K/2048K/4096K/8192K/1638K4/32768K and “No Limit” .
• Broadcast Rate	This function allows to filter the broadcast storm traffic, the available options are 1K/2K/4K/8K/16K/32K/64K/128K/256K/512K/1024K/2048K/4096K/8192K/1638K4/32768K and “No Limit” .
• Multicast Rate	This function allows to filter the multicast storm traffic, the available options are 1K/2K/4K/8K/16K/32K/64K/128K/256K/512K/1024K/2048K/4096K/8192K/1638K4/32768K and “No Limit” .
• Flooded unicast Rate	This function allows to filter the flooded unicast storm traffic, the available options are 1K/2K/4K/8K/16K/32K/64K/128K/256K/512K/1024K/2048K/4096K/8192K/1638K4/32768K and “No Limit” .

Table 4-5 Description of the Storm Control

4.6 VLANs

A Virtual LAN (VLAN) is a logical network grouping that limits the broadcast domain. It allows you to isolate network traffic so only members of the VLAN receive traffic from the same VLAN members. Basically, creating a VLAN from a switch is logically equivalent of reconnecting a group of network devices to another Layer 2 switch. However, all the network devices are still plugged into the same switch physically.

The GSW-1602SF/GSW-2404SF/GSW-2416SF switch supports IEEE 802.1Q (tagged-based) and Port-Based VLAN setting in web management page. In the default configuration, VLAN support is “**802.1Q**”.

Port-based VLAN

Port-based VLAN limits traffic that flows into and out of switch ports. Thus, all devices connected to a port are members of the VLAN(s) the port belongs to, whether there is a single computer directly connected to a switch, or an entire department.

On port-based VLAN, NICs do not need to be able to identify 802.1Q tags in packet headers. NICs send and receive normal Ethernet packets. If the packet's destination lies on the same segment, communications take place using normal Ethernet protocols. Even though this is always the case, when the destination for a packet lies on another switch port, VLAN considerations come into play to decide if the packet is dropped by the switch or delivered.

IEEE 802.1Q VLANs

IEEE 802.1Q (tagged) VLANs are implemented on the switch. 802.1Q VLANs require tagging, which enables them to span the entire network (assuming all switches on the network are IEEE 802.1Q-compliant).

VLANs allow a network to be segmented in order to reduce the size of broadcast domains. All packets entering a VLAN will only be forwarded to the stations (over IEEE 802.1Q-enabled switches) that are members of that VLAN, and this includes broadcast, multicast, and unicast packets from unknown sources.

VLANs can also provide a level of security to your network. IEEE 802.1Q VLANs will only deliver packets between stations that are members of the VLAN. Any port can be configured as either tagging or untagging. The untagging feature of IEEE 802.1Q VLAN allows VLANs to work with legacy switches that don't recognize VLAN tags in packet headers. The tagging feature allows VLANs to span multiple 802.1Q-compliant switches through a single physical connection and allows Spanning Tree to be enabled on all ports and work normally.

Any port can be configured as either tagging or untagging. The untagging feature of IEEE 802.1Q VLAN allows VLANs to work with legacy switches that don't recognize VLAN tags in packet headers. The tagging feature allows VLANs to span multiple 802.1Q-compliant switches through a single physical connection and allows Spanning Tree to be enabled on all ports and work normally.

4.6.1 VLAN Membership

This function group individual ports into a small “Virtual” network of their own to be independent of the other ports. The screen in **Figure 4-7** appears.

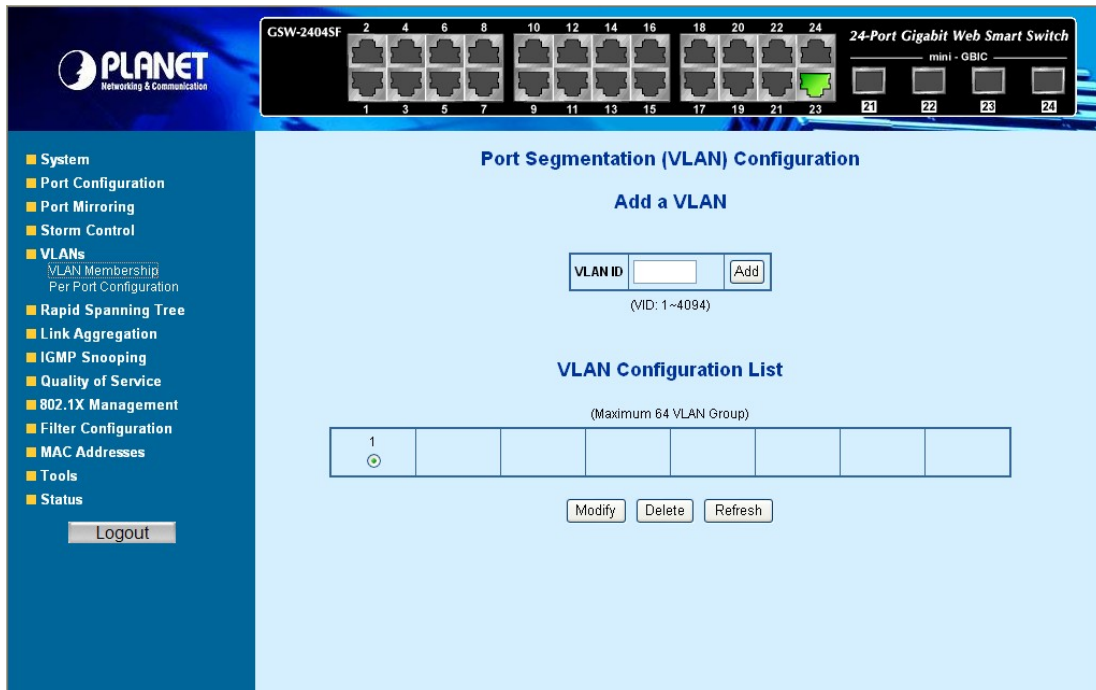

Figure 4-7 VLAN Membership screen

The page includes the following items: **table 4-6** description of the Add a VLAN.

• Item	Description
• VLAN ID -	Specify the VLAN Identifier for the new VLAN. (You can only enter data in this field when you are creating a new VLAN.) The range of the VLAN ID is (1 to 4094) .
• Add	To add a new VLAN Group with the specify VLAN ID. Once the Add button be pressed. The page will be redirect to have the VLAN member assign page.
• Modify	To modify an existence VLAN Group- adds new member ports or remove ports from the selected VLAN Group.
• Delete	Delete the selected VLAN Group.
• Refresh	Refresh the VLAN Configuration screen

Table 4-6 Description of the Add a VLAN

4.6.1.1 Add a VLAN Group

The PLANET Web-Smart switch supports up to 64 active VLAN groups and the range for the VLAN ID is **1-4094**.

1. To add a VLAN group, filed in the **VLAN ID** (from 1-4094) and please press “**Add**” button, the new VLAN Setup screen will pop out.
2. Checked the Member box to select the members for the VLAN group.
3. After setup completed, please press “**Apply**” to take affect.

As show in **Figure 4-8** and **Figure 4-9**

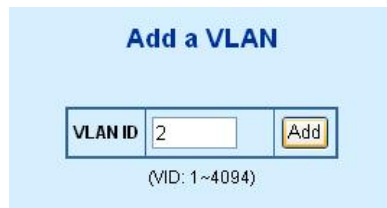

Figure 4-8 Add a VLAN screen

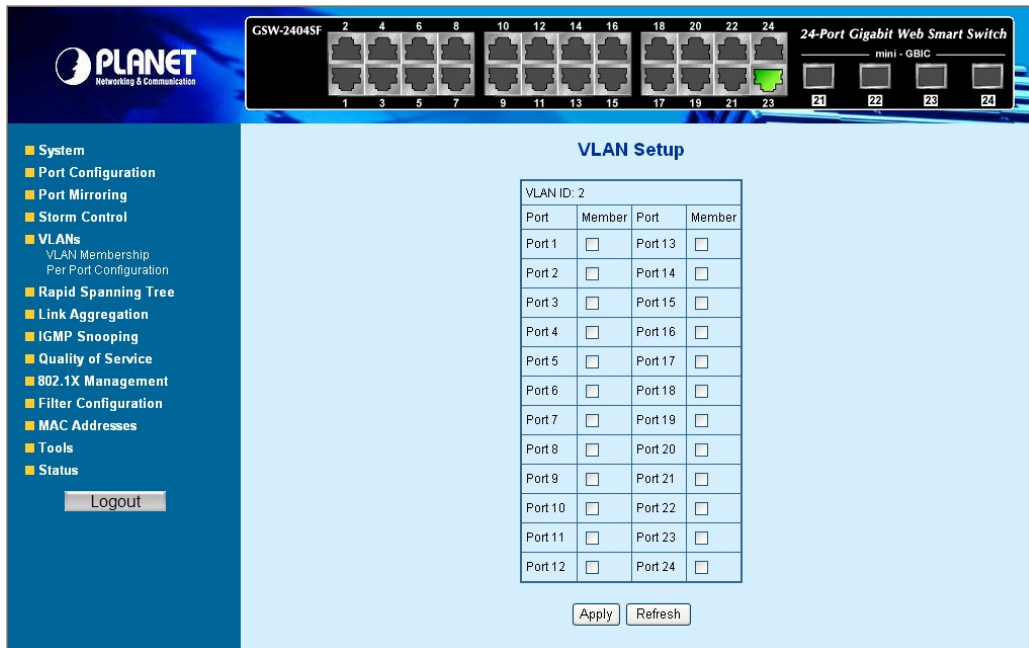

Figure 4-9 VLAN Member Setup screen

4.6.1.2 Modify the VLAN Group Member

Once you want to modify the existence VLAN Group member or delete a existence VLAN Group. Refer to the following steps.

1. To modify the members of an existence VLAN Group, check the VLAN Group ID and press “**Modify**” button. the ID VLAN Setup screen will pop out.
2. To add/remove a port from specific VLAN group, just check/cancel the Member check Box and press “**Apply**” to take affect.
3. To delete an existence VLAN Group, check the VLAN Group ID and press “**Delete**” button.

As show in **Figure 4-10** appears.

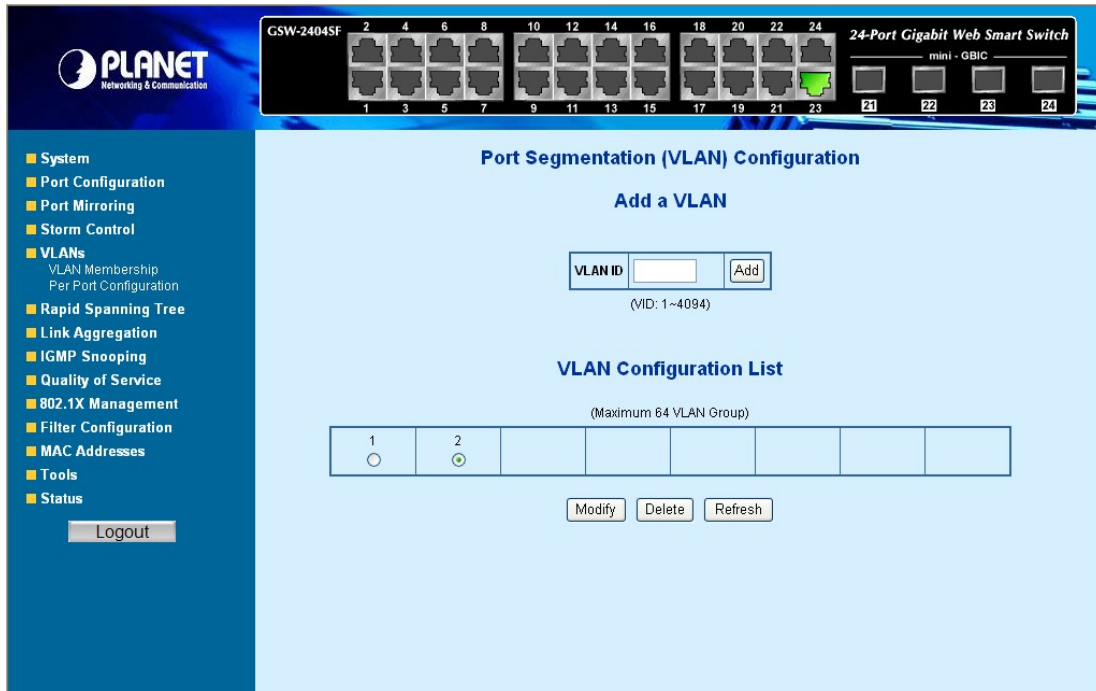

Figure 4-10 VLAN Group – member modify and delete VLAN Group screen

Note: Once the VLAN Group be deleted, the Ports with the PVID set to this VLAN Group have to re-configure the PVID. Or the PVID will be set to “None”

4.6.2 Per Port Configuration

The VLAN Per Port Configuration page contains fields for managing ports that are part of a VLAN. The port default VLAN ID (PVID) is configured on the VLAN Port Configuration page. All untagged packets arriving to the device are tagged by the ports PVID. The screen in **Figure 4-11** appears and the objection explanation in table 4-7 appears.

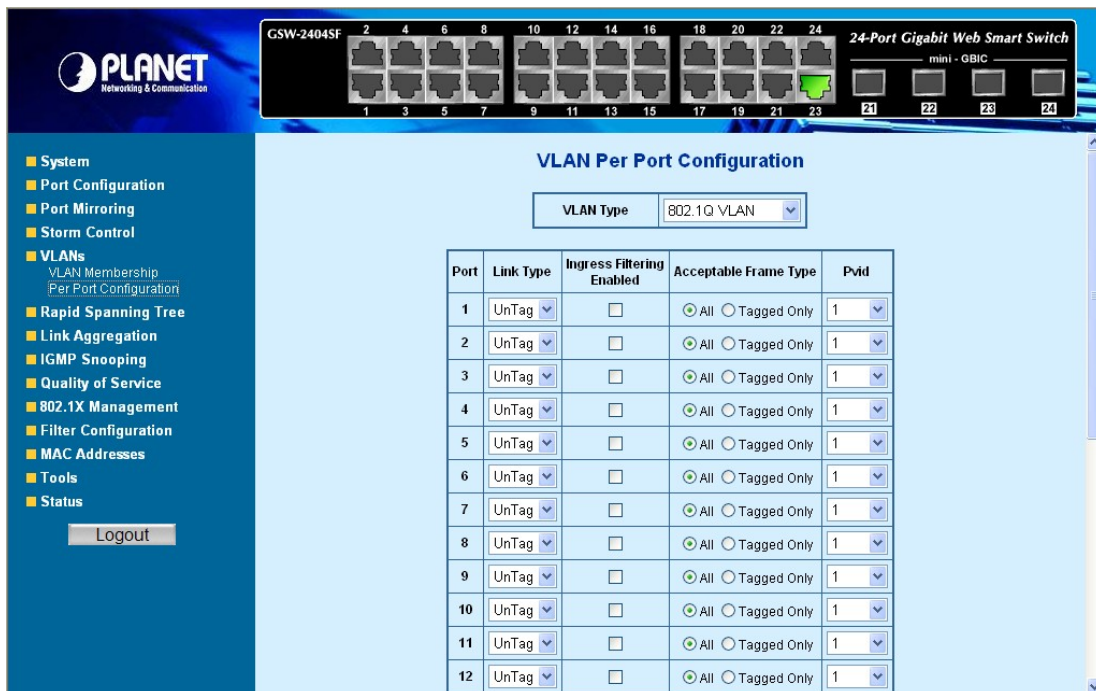

Figure 4-11 VLAN Port Configuration

The page includes the following fields: **table 4-7** description of the VLAN Per Port Configuration.

• Item	Description
<ul style="list-style-type: none"> • VLAN Type - 	<p>There're two VLAN mode support – 802.1Q VLAN and Port-Bas VLAN</p> <ul style="list-style-type: none"> • 802.1Q – Packets income will be tagged with VID as the PVID setting. All ports on the switch belong to default VLAN (VID 1). • Port-Base - Packets can only be broadcast among other members of the same VLAN group. Note all unselected ports are treated as belonging to the default system VLAN. <p>If port-based VLAN are enabled, then VLAN-tagging feature is ignored.</p>
<ul style="list-style-type: none"> • Port - 	<p>Select the physical interface for which you want to display or configure data.</p>
<ul style="list-style-type: none"> • Link Type - 	<p>Allow 802.1Q Untagged or Tagged VLAN for selected port.</p> <p>When adding a VLAN to selected port, it tells the switch whether to keep or remove the tag from a frame on egress.</p> <ul style="list-style-type: none"> • Untag: outgoing frames without VLAN-Tagged. • Tagged: outgoing frames with VLAN-Tagged.
<ul style="list-style-type: none"> • Ingress Filtering Enable- 	<p>Enabled - the frame is discarded if this port is not a member of the VLAN with which this frame is associated. In a tagged frame, the VLAN is identified by the VLAN ID in the tag. In an untagged frame, the VLAN is the Port VLAN ID specified for the port that received this frame.</p> <p>Disabled - all frames are forwarded in accordance with the 802.1Q VLAN bridge specification. The factory default is disabled.</p>
<ul style="list-style-type: none"> • Acceptable Frame Types - 	<p>Specifies the types of frames that may be received on this port. The options are 'All' and 'Tagged only'.</p> <ul style="list-style-type: none"> • All- untagged frames or priority tagged frames received on this port are accepted and assigned the value of the Port VLAN ID for this port. • Tagged only - untagged frames or priority tagged frames received on this port are discarded. <p>With either option, VLAN tagged frames are forwarded in accordance to the 802.1Q VLAN specification.</p>
<ul style="list-style-type: none"> • PVID - 	<p>Allow assign PVID for selected port. The range for the PVID is 1-4094</p> <p>The PVID will be inserted into all untagged frames entering the ingress port. The PVID must as same as the VLAN ID that the port belong to VLAN group, or the untagged traffic will be dropped.</p>

Table 4-7 Description of the VLAN Per Port Configuration

4.6.3 VLAN setting example:

4.6.3.1 Two separate 802.1Q VLAN

The diagram shows how the switch handle Tagged and Untagged traffic flow for two VLANs. VLAN Group 2 and VLAN Group 3 are separated VLAN. Each VLAN isolate network traffic so only members of the VLAN receive traffic from the same VLAN members. The screen in **Figure 4-12** appears and **Table 4-8** describes the port configuration of switch.

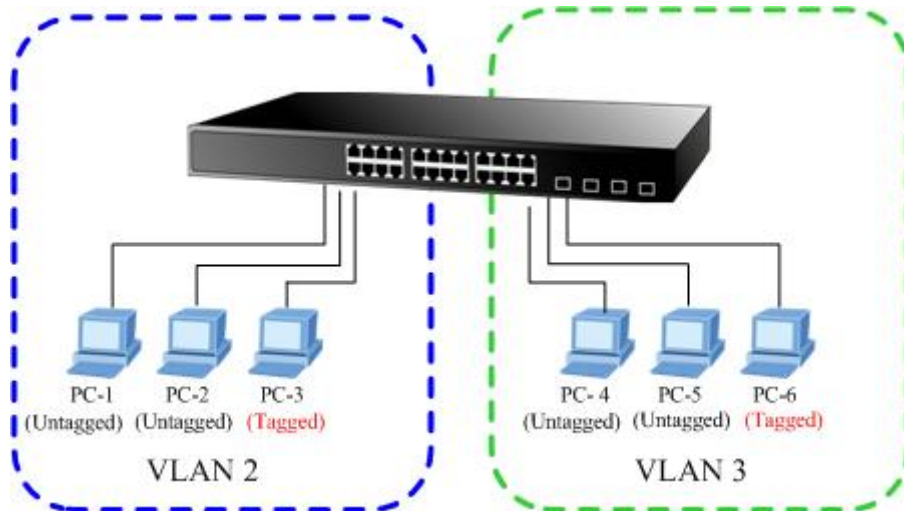

Figure 4-12 two separate VLAN diagram

VLAN Group	VID	Untagged Members	Tagged Members
VLAN Group 1	1	Port-7~Port-24	N/A
VLAN Group 2	2	Port-1,Port-2	Port-3
VLAN Group 3	3	Port-4,Port-5	Port-6

Table 4-8 VLAN and Port Configuration

The scenario described as follow:

■ Untagged packet entering VALN 2

1. While **[PC-1]** transmit an **untagged** packet enters **Port-1**, the switch will tag it with a **VLAN Tag=2**. **[PC-2]** and **[PC-3]** will received the packet through **Port-2** and **Port-3**.
2. **[PC-4],[PC-5]** and **[PC-6]** received no packet.
3. While the packet leaves **Port-2**, it will be stripped away it tag becoming an **untagged** packet.
4. While the packet leaves **Port-3**, it will keep as a **tagged** packet with **VLAN Tag=2**.

■ Tagged packet entering VLAN 2

5. While **[PC-3]** transmit a **tagged** packet with **VLAN Tag=2** enters **Port-3**, **[PC-1]** and **[PC-2]** will received the packet through **Port-1** and **Port-2**.
6. While the packet leaves **Port-1** and **Port-2**, it will be stripped away it tag becoming an **untagged** packet.

■ Untagged packet entering VLAN 3

1. While [PC-4] transmit an **untagged** packet enters **Port-4**, the switch will tag it with a **VLAN Tag=3**. [PC-5] and [PC-6] will received the packet through **Port-5** and **Port-6**.
2. While the packet leaves **Port-5**, it will be stripped away its tag becoming an **untagged** packet.
3. While the packet leaves **Port-6**, it will keep as a **tagged** packet with **VLAN Tag=3**.

 **Note:** At this example, VLAN Group 1 just set as default VLAN, but only focus on VLAN 2 and VLAN 3 traffic flow

Setup steps

1. Create VLAN Group

Set VLAN Group 1 = default-VLAN with VID (VLAN ID)=1

Add two VLANs – VLAN 2 and VLAN 3

VLAN Group 2 with VID=2

VLAN Group 3 with VID=3

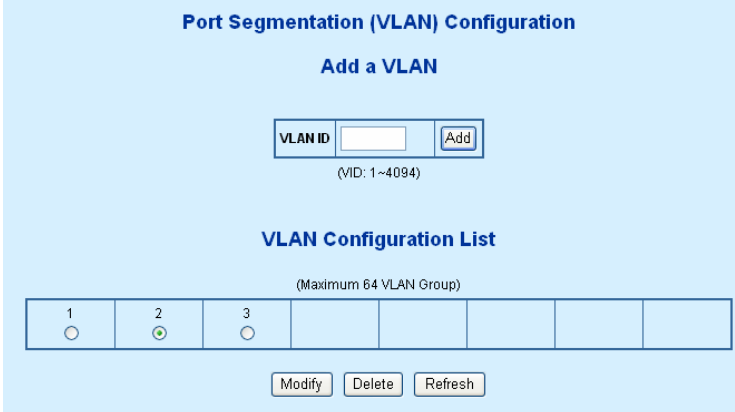

VLAN Configuration List							
(Maximum 64 VLAN Group)							
1	2	3					
<input type="radio"/>	<input checked="" type="radio"/>	<input type="radio"/>					

Figure 4-13 Add new VLAN Group screen

2. Assign VLAN Member :

VLAN 2 : Port-1,Port-2 and Port-3

VLAN 3 : Port-4, Port-5 and Port-6

VLAN 1 : All other ports – Port-7~Port-24

VLAN Setup

VLAN ID: 2			
Port	Member	Port	Member
Port 1	<input checked="" type="checkbox"/>	Port 13	<input type="checkbox"/>
Port 2	<input checked="" type="checkbox"/>	Port 14	<input type="checkbox"/>
Port 3	<input checked="" type="checkbox"/>	Port 15	<input type="checkbox"/>
Port 4	<input type="checkbox"/>	Port 16	<input type="checkbox"/>
Port 5	<input type="checkbox"/>	Port 17	<input type="checkbox"/>
Port 6	<input type="checkbox"/>	Port 18	<input type="checkbox"/>
Port 7	<input type="checkbox"/>	Port 19	<input type="checkbox"/>
Port 8	<input type="checkbox"/>	Port 20	<input type="checkbox"/>
Port 9	<input type="checkbox"/>	Port 21	<input type="checkbox"/>
Port 10	<input type="checkbox"/>	Port 22	<input type="checkbox"/>
Port 11	<input type="checkbox"/>	Port 23	<input type="checkbox"/>
Port 12	<input type="checkbox"/>	Port 24	<input type="checkbox"/>

VLAN Setup

VLAN ID: 3			
Port	Member	Port	Member
Port 1	<input type="checkbox"/>	Port 13	<input type="checkbox"/>
Port 2	<input type="checkbox"/>	Port 14	<input type="checkbox"/>
Port 3	<input type="checkbox"/>	Port 15	<input type="checkbox"/>
Port 4	<input checked="" type="checkbox"/>	Port 16	<input type="checkbox"/>
Port 5	<input checked="" type="checkbox"/>	Port 17	<input type="checkbox"/>
Port 6	<input checked="" type="checkbox"/>	Port 18	<input type="checkbox"/>
Port 7	<input type="checkbox"/>	Port 19	<input type="checkbox"/>
Port 8	<input type="checkbox"/>	Port 20	<input type="checkbox"/>
Port 9	<input type="checkbox"/>	Port 21	<input type="checkbox"/>
Port 10	<input type="checkbox"/>	Port 22	<input type="checkbox"/>
Port 11	<input type="checkbox"/>	Port 23	<input type="checkbox"/>
Port 12	<input type="checkbox"/>	Port 24	<input type="checkbox"/>

Figure 4-14 Assign VLAN members for VLAN 2 and VLAN 3

Remember to remove the Port 1 – Port 6 from VLAN 1 membership, since the Port 1 – Port 6 had be assigned to VLAN 2 and VLAN 3.

VLAN Setup

VLAN ID: 1			
Port	Member	Port	Member
Port 1	<input type="checkbox"/>	Port 13	<input checked="" type="checkbox"/>
Port 2	<input type="checkbox"/>	Port 14	<input checked="" type="checkbox"/>
Port 3	<input type="checkbox"/>	Port 15	<input checked="" type="checkbox"/>
Port 4	<input type="checkbox"/>	Port 16	<input checked="" type="checkbox"/>
Port 5	<input type="checkbox"/>	Port 17	<input checked="" type="checkbox"/>
Port 6	<input type="checkbox"/>	Port 18	<input checked="" type="checkbox"/>
Port 7	<input checked="" type="checkbox"/>	Port 19	<input checked="" type="checkbox"/>
Port 8	<input checked="" type="checkbox"/>	Port 20	<input checked="" type="checkbox"/>
Port 9	<input checked="" type="checkbox"/>	Port 21	<input checked="" type="checkbox"/>
Port 10	<input checked="" type="checkbox"/>	Port 22	<input checked="" type="checkbox"/>
Port 11	<input checked="" type="checkbox"/>	Port 23	<input checked="" type="checkbox"/>
Port 12	<input checked="" type="checkbox"/>	Port 24	<input checked="" type="checkbox"/>

Figure 4-15 Remove specify ports from VLAN 1 member

Note: It's imporit to remove the VLAN members from VLAN 1 configuration. Or the ports would become overlap setting. (About the overlapped VLAN configuration, see next VLAN configure sample)

3. Assign PVID for each port:

Port-1,Port-2 and Port-3 : PVID=2

Port-4,Port-5 and Port-6 : PVID=3

Port-7~Port-24 : PVID=1

4. Enable VLAN Tag for specific ports

Link Type : *Port-3 (VLAN-2)* and *Port-6 (VLAN-3)*

The Per Port VLAN configuration in Figure 4-16 appears.

VLAN Per Port Configuration				
VLAN Type		802.1Q VLAN		
Port	Link Type	Ingress Filtering Enabled	Acceptable Frame Type	Pvid
1	UnTag	<input type="checkbox"/>	<input checked="" type="radio"/> All <input type="radio"/> Tagged Only	2
2	UnTag	<input type="checkbox"/>	<input checked="" type="radio"/> All <input type="radio"/> Tagged Only	2
3	Tag	<input type="checkbox"/>	<input checked="" type="radio"/> All <input type="radio"/> Tagged Only	2
4	UnTag	<input type="checkbox"/>	<input checked="" type="radio"/> All <input type="radio"/> Tagged Only	3
5	UnTag	<input type="checkbox"/>	<input checked="" type="radio"/> All <input type="radio"/> Tagged Only	3
6	Tag	<input type="checkbox"/>	<input checked="" type="radio"/> All <input type="radio"/> Tagged Only	3
7	UnTag	<input type="checkbox"/>	<input checked="" type="radio"/> All <input type="radio"/> Tagged Only	1
8	UnTag	<input type="checkbox"/>	<input checked="" type="radio"/> All <input type="radio"/> Tagged Only	1

Figure 4-16 Port 1-Port 6 VLAN Configuration

4.6.3.2 Two VLANs with overlap area

Follow the example of 4.6.3.1. There're two exist separate VLANs – VLAN 2 and VLAN 3, and the PCs of each VLANs are not able to access each other of different VLANs. But they all need to access with the same server. The screen in Figure 4-17 appears. This section will show you how to configure the port for the server – that could be accessed by both VLAN 2 and VLAN 3.

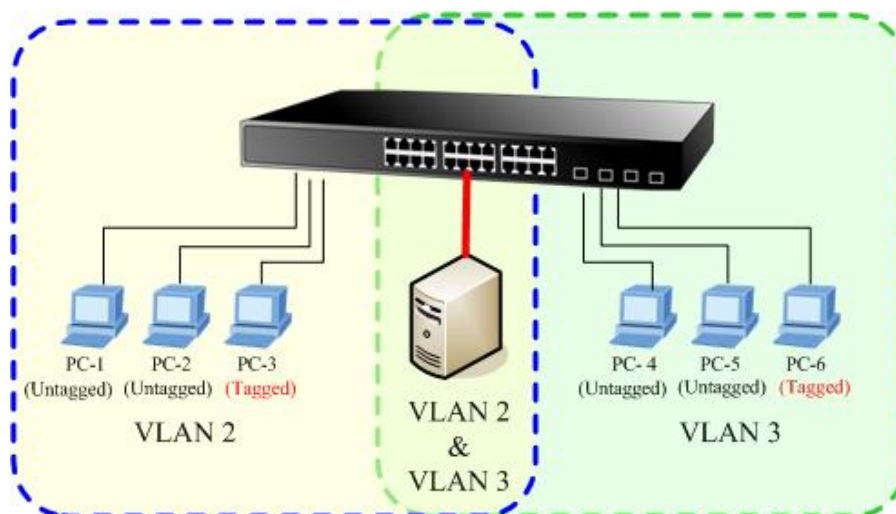

Figure 4-17 A Server connect to the VLAN overlap area

1. Specify **Port-7** on the device to connect to the server.
2. Assign **Port-7** to both **VLAN 2** and **VLAN 3** at the VLAN Member configuration page. The screen in Figure 4-18 appears.

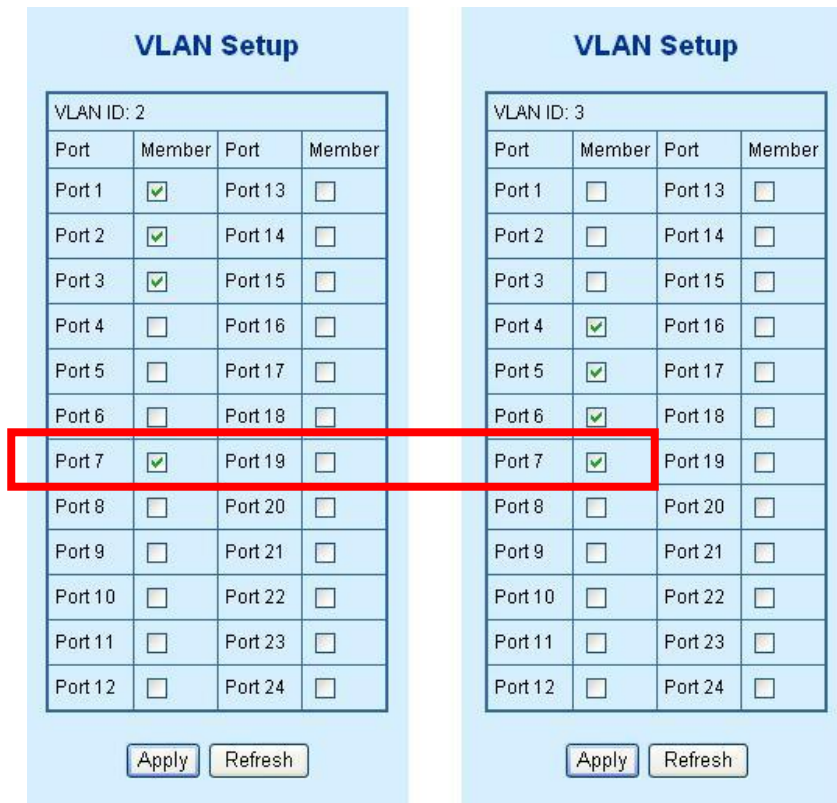

Figure 4-18 VLAN overlap port setting

3. Define a **VLAN 1** as a “Public Area” that overlapping with both **VLAN 2** members and **VLAN 3** members.

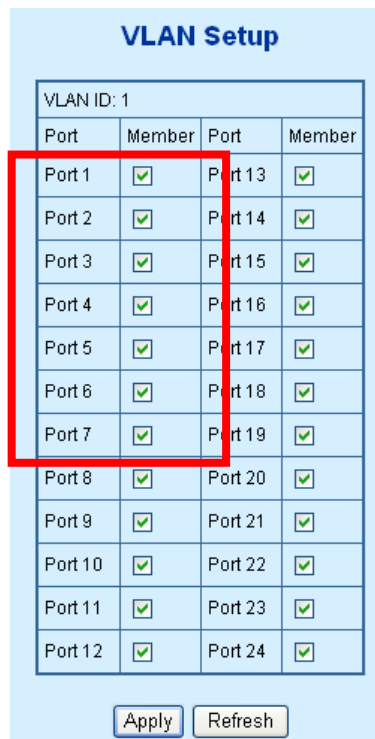

Figure 4-19 VLAN 1 – The public area member assign

4. Setup **Port-7** with “**PVID=1**” at VLAN Per Port Configuration page. The screen in Figure 4-20 appears.

VLAN Per Port Configuration

VLAN Type: 802.1Q VLAN

Port	Link Type	Ingress Filtering Enabled	Acceptable Frame Type	Pvid
1	UnTag	<input type="checkbox"/>	<input checked="" type="radio"/> All <input type="radio"/> Tagged Only	2
2	UnTag	<input type="checkbox"/>	<input checked="" type="radio"/> All <input type="radio"/> Tagged Only	2
3	Tag	<input type="checkbox"/>	<input checked="" type="radio"/> All <input type="radio"/> Tagged Only	2
4	UnTag	<input type="checkbox"/>	<input checked="" type="radio"/> All <input type="radio"/> Tagged Only	3
5	UnTag	<input type="checkbox"/>	<input checked="" type="radio"/> All <input type="radio"/> Tagged Only	3
6	Tag	<input type="checkbox"/>	<input checked="" type="radio"/> All <input type="radio"/> Tagged Only	3
7	UnTag	<input type="checkbox"/>	<input checked="" type="radio"/> All <input type="radio"/> Tagged Only	1
8	UnTag	<input type="checkbox"/>	<input checked="" type="radio"/> All <input type="radio"/> Tagged Only	1

Figure 4-20 Setup Port-7 with PVID-1

That is, although the VLAN 2 members: Port-1 to Port-3 and VLAN 3 members: Port-4 to Port-6 also belongs to VLAN 1. But with different PVID settings, packets from VLAN 2 or VLAN 3 is not able to access to the other VLAN.

4.6.3.3 VLAN Trunking between two 802.1Q aware switch

The most cases are used for “**Uplink**” to other switches. VLANs are separated at different switches, but they need to access with other switches within the same VLAN group. The screen in Figure 4-21 appears.

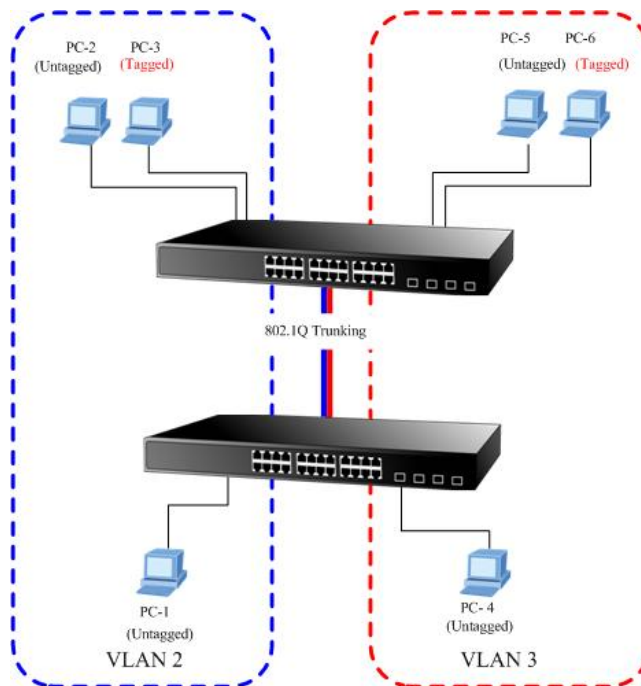

Figure 4-21 802.1Q Trunking with other VLAN aware device

About the VLAN ports connect to the hosts, please refer to 4.5.3.1 and 4.5.3.2 examples. The following steps will focus on the VLAN **Trunk port** configuration.

1. Specify **Port-8** to be the 802.1Q VLAN **Trunk port**, and the Trunking port must be a **Tagged** port while egress. The Port-8 configuration as the following screen in **Figure 4-22**.

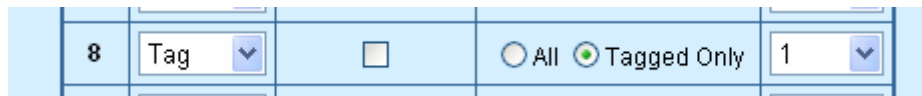

Figure 4-22 The configuration of VLAN Trunk port

2. Assign the VLAN Trunk Port to be the member of each VLAN – which wants to be aggregated. At this sample, add **Port-8** to be **VLAN 2** and **VLAN 3** member port.

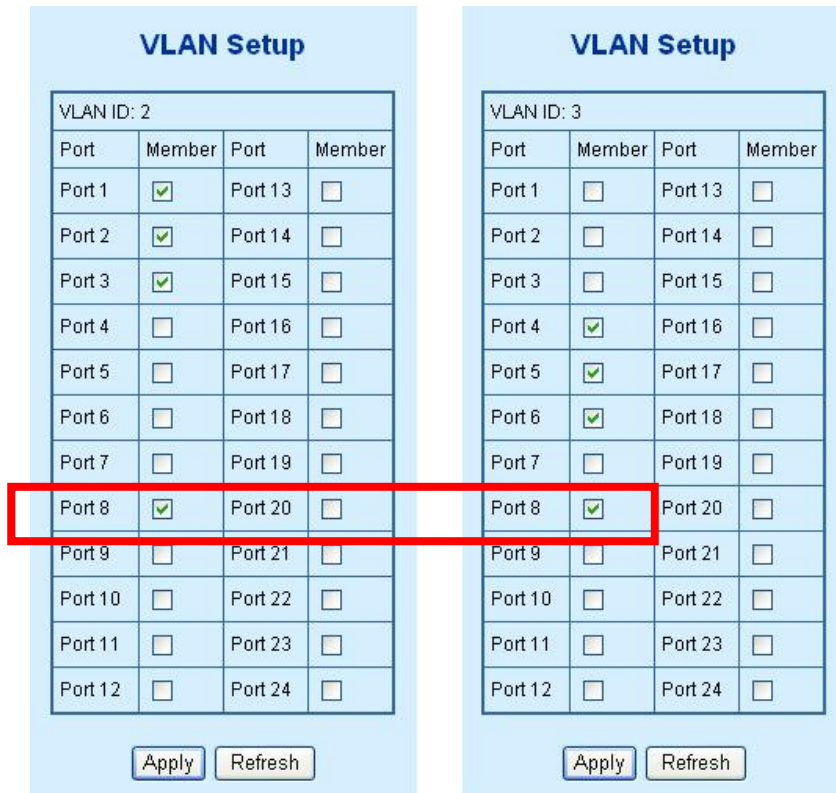

Figure 4-23 Add VLAN Trunk port to each VLAN

3. Repeat Step 1 and 2, setup the VLAN Trunk port at the partner switch.
4. To add more VLANs to join the VLAN trunk, repeat Step 2 to assign the Trunk port to the VLANs.

4.7 Rapid Spanning Tree

Spanning Tree Protocol (STP) provides tree topography for any arrangement of bridges. STP also provides one path between end stations on a network, eliminating loops.

Rapid Spanning Tree Protocol (RSTP) - While Classic Spanning Tree guarantees preventing L2 forwarding loops in a general network topology, convergence can take up to 30-60 seconds. The convergence time is considered too long for many applications. When network topology allows, faster convergence may be possible. The **Rapid Spanning Tree Protocol (RSTP)** detects and uses of network topologies that provide faster convergence of the spanning tree, without creating forwarding loops.

The devices support the following Spanning Tree protocols:

- **Compatible -- Spanning Tree Protocol (STP)**: Provides a single path between end stations, avoiding and eliminating loops.
- **Normal -- Rapid Spanning Tree Protocol (RSTP)** : Detects and uses of network topologies that provide faster spanning tree convergence, without creating forwarding loops.

 **Note:** The GSW-1602SF/GSW-2404SF/GSW-2416SF implement the Rapid Spanning Protocol as the default spanning tree protocol. While select “Compatibles” mode, the system use the **RSTP** (802.1w) to compatible and co work with another **STP** (802.1d)’s BPDU control packets.

This page is to enable/disable the Spanning Tree protocol. These Switch support IEEE 802.1d Spanning Tree (**STP**), IEEE 802.1w Rapid Spanning Tree (**RSTP**). The screen in **Figure 4-24** appears.

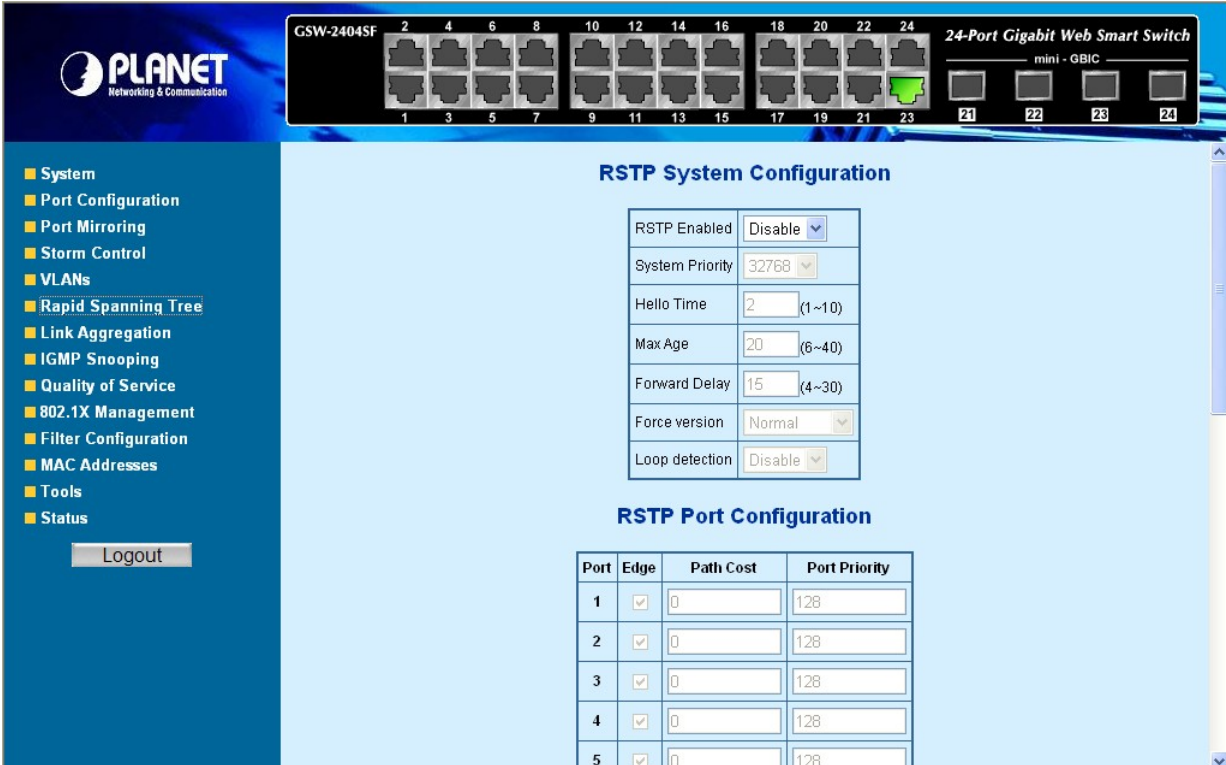

RSTP System Configuration

RSTP Enabled	Disable
System Priority	32768
Hello Time	2 (1~10)
Max Age	20 (6~40)
Forward Delay	15 (4~30)
Force version	Normal
Loop detection	Disable

RSTP Port Configuration

Port	Edge	Path Cost	Port Priority
1	<input checked="" type="checkbox"/>	0	128
2	<input checked="" type="checkbox"/>	0	128
3	<input checked="" type="checkbox"/>	0	128
4	<input checked="" type="checkbox"/>	0	128
5	<input checked="" type="checkbox"/>	0	128

Figure 4-24 Rapid Spanning Tree System/Port Configuration

4.7.1 RSTP System Configuration

The “RSTP System Configuration” table allows configuring the spanning tree parameters.

RSTP System Configuration	
RSTP Enabled	Disable
System Priority	32768
Hello Time	2 (1~10)
Max Age	20 (6~40)
Forward Delay	15 (4~30)
Force version	Normal
Loop detection	Disable

Figure 4-25 RSTP System Configuration

The page includes the following fields: **table 4-9** description of the RSTP System Configuration.

• Item	Description
• RSTP Enabled	<p>Enabled –Enabled the RSTP.</p> <p>Disabled -Disable the RSTP.</p>
• System Priority -	<p>Specifies the bridge priority value. When switches or bridges are running STP, each is assigned a priority. After exchanging BPDUs, the switch with the lowest priority value becomes the Root Bridge. The bridge priority value is provided in increments of 4096 (4K increments). For example, 0, 4096, 8192, etc.</p> <p>The default value is 32768.</p>
• Hello Time	<p>Specifies the device Hello Time. The Hello Time indicates the amount of time in seconds a root bridge waits between configuration messages.</p> <p>Value Range : 1-10</p> <p>The default is 2 seconds.</p>
• Max Age	<p>Specifies the device Maximum Age Time. The Maximum Age Time indicates the amount of time in seconds a bridge waits before sending configuration messages.</p> <p>Value Range : 6-40</p> <p>The default max age is 20 seconds.</p>
• Forward Delay	<p>Specifies the device forward delay time. The Forward Delay Time indicates the amount of time in seconds a bridge remains in a listening and learning state before forwarding packets.</p> <p>Value Range : 4-30</p> <p>The default is 15 seconds.</p>
• Force version	<p>Specifies the Force Protocol Version parameter for the switch. The options are Normal and Compatible</p> <p>Normal – Rapid STP (802.1w): Detects and uses of network topologies that</p>

	provide faster spanning tree convergence, without creating forwarding loops. Compatible – Classis STP (802.1d): Provides a single path between end stations, avoiding and eliminating loops.
• Loop detection	Enable or disable the loop detection.

Table 4-9 Description of the RSTP System Configuration

Note:

- **Max Age** - The value lies between 6 and 40, with the value being less than or equal to "(2 * Bridge Forward Delay) - 1" and greater than or equal to "2 * (Bridge Hello Time +1)". The default value is 20.
- **Hello Time** - The value being less than or equal to "(Bridge Max Age / 2) - 1". The default hello time value is 2.
- **Forward Delay**- Bridge Forward Delay must be greater or equal to "(Bridge Max Age / 2) + 1". The time range is from 4 seconds to 30 seconds. The default value is 15.

4.7.2 RSTP Port Configuration

The RSTP Port Configuration page contains fields for assigning RSTP properties to individual ports. The screen in **Figure 4-26** appears.

RSTP Port Configuration			
Port	Edge	Path Cost	Port Priority
1	<input checked="" type="checkbox"/>	0	128
2	<input checked="" type="checkbox"/>	0	128
3	<input checked="" type="checkbox"/>	0	128
4	<input checked="" type="checkbox"/>	0	128
5	<input checked="" type="checkbox"/>	0	128
6	<input checked="" type="checkbox"/>	0	128
7	<input checked="" type="checkbox"/>	0	128
8	<input checked="" type="checkbox"/>	0	128
9	<input checked="" type="checkbox"/>	0	128
10	<input checked="" type="checkbox"/>	0	128
11	<input checked="" type="checkbox"/>	0	128
12	<input checked="" type="checkbox"/>	0	128

Figure 4-26 RSTP Port Configuration

The page includes the following fields: table 4-10 description of the RSTP Port Configuration.

• Item	Description
• Port	Indicate port 1 to port 24.
• Edge	Enable or disable the function.

<ul style="list-style-type: none"> • Path Cost 	<p>The port contribution to the root path cost. The path cost is adjusted to a higher or lower value, and is used to forward traffic when a path being rerouted.</p> <p>Value Range : 1-20000000</p> <p>Default Path Cost -- The default path cost of the port is automatically set by the port speed and the default path cost method. The default values for path costs are:</p> <ul style="list-style-type: none"> - Ethernet - 2000000 - Fast Ethernet - 200000 - Gigabit Ethernet - 20000
<ul style="list-style-type: none"> • Port Priority 	<p>The value of the port priority. The default value is "128".</p>

Table 4-10 Description of the RSTP Port Configuration

4.7.3 RSTP Status

The RSTP Status page display the current STP bridge , roor bridge and per port stp status.

To open **RSTP Status** screen perform the folling:

1. Click Status -> RSTP Status
2. The "RSTP VLAN Bridge Overview" and "RSTP Port Status" screen is displayed as in Figure 4-27.

The screenshot shows the RSTP Status screen for a Planet GSW-2404SF switch. The interface includes a navigation menu on the left with options like System, Port Configuration, Storm Control, VLANs, Rapid Spanning Tree, Link Aggregation, IGMP Snooping, Quality of Service, 802.1X Management, Filter Configuration, MAC Addresses, Tools, and Status. The main content area is divided into two sections:

RSTP VLAN Bridge Overview

VLAN Id	Bridge Id	Hello Time	Max Age	Fwd Delay	Topology	Root Id
2	32770:00-30-4f-60-6b-b8	2	20	15	Steady	This switch is Root!
1	32769:00-30-4f-60-6b-a2	2	20	15	Steady	This switch is Root!

Below the table is a "Refresh" button.

RSTP Port Status

Port/Group	Vlan Id	Path Cost	Edge Port	P2p Port	Protocol	Port State
Port 1						Non-STP
Port 2						Non-STP
Port 3						Non-STP
Port 4						Non-STP
Port 5						Non-STP
Port 6						Non-STP
Port 7						Non-STP
Port 8						Non-STP
Port 9						Non-STP
Port 10						Non-STP
Port 11						Non-STP

Figure 4-27 RSTP Status screen

■ **RSTP VLAN Bridge Overview**

The information of the RSTP Root shows in the Bridge overview table. The screen in Figure 4-28 appears.

VLAN Id	Bridge Id	Hello Time	Max Age	Fwd Delay	Topology	Root Id
1	32768:00-01-c1-00-00-02	2	20	15	Steady	This switch is Root!

Refresh

Figure 4-28 RSTP Status screen

The page includes the following fields: table 4-11 description of the RSTP VLAN Bridge Overview.

• Item	Description
• VLAN Id	Identifies VLANs associated with the Rapid Spanning Tree.
• Bridge IDd	Identifies the Bridge priority and MAC address.
• Hello Time	Minimum time between transmissions of Configuration BPDUs.
• Max Age	Path Cost to the Designated Root for the spanning tree.
• Forward Delay	Derived value of the Root Port Bridge Forward Delay parameter.
• Topology	Specifies the Tolology change status of the current operation. If no topology change happened, the table show “Steady” .
• Root Id	Identifies the Root Bridge priority and MAC address.

Table 4-11 Description of the RSTP VLAN Bridge Overview

■ **RSTP Port Status**

The information of the RSTP per Port and Trunk group shows in the RSTP Port Status table. The screen in Figure 4-29 appears.

RSTP Port Status						
Port/Group	Vlan Id	Path Cost	Edge Port	P2p Port	Protocol	Port State
Port 1						Disabled
Port 2						Disabled
Port 3						Disabled
Port 4	1	200000	yes	yes	RSTP	Forwarding
Port 5						Disabled
Port 6						Disabled
Port 7						Disabled
Port 8						Disabled
Port 9						Disabled

Figure 4-29 RSTP Status screen

The page includes the following fields: table 4-12 description of the RSTP Port status.

• Item	Description
• Port/Group	Port or Link Aggregation group on which Rapid STP is enabled
• VLAN Id	Port or Link Aggregation interfaces associated with VLANs associated with the Rapid Spanning Tree.
• Path Cost	Cost of the port participating in the RSTP topology. Ports with a lower cost are less likely to be blocked if STP detects loops.
• Edge Port	Indicates whether the port is enabled as an edge port. It takes the value "Yes" or "No".
• P2p Port	The Point-to-Point operating state. This is the actual device port link type.
• Protocol	Indicates the current spanning protocol on the ports.
• Port State	<p>The current port STP state. If enabled, the port state determines what forwarding action is taken on traffic. Possible port states are:</p> <ul style="list-style-type: none"> • Disabled -- The port link is currently down. • Blocking -- The port is currently blocked and cannot be used to forward traffic or learn MAC addresses. Blocking is displayed when Classic STP is enabled. • Listening -- The port is currently in the listening mode. The port cannot forward traffic nor can it learn MAC addresses. • Learning -- The port is currently in the learning mode. The port cannot forward traffic however it can learn new MAC addresses. • Forwarding -- The port is currently in the forwarding mode. The port can forward traffic and learn new MAC addresses.

Table 4-12 Description of the RSTP Port status

 **Note:** A port transitions from one state to another as follows:

- From initialization (switch boot) to blocking
 - From blocking to listening or to disabled
 - From listening to learning or to disabled
 - From learning to forwarding or to disabled
 - From forwarding to disabled
 - From disabled to blocking
-

4.8 Link Aggregation

Port Aggregation optimizes port usage by linking a group of ports together to form a single Link Aggregated Groups (LAGs). Port Aggregation multiplies the bandwidth between the devices, increases port flexibility, and provides link redundancy.

Each LAG is composed of ports of the same speed, set to full-duplex operations. Ports in a LAG, can be of different media types (UTP/Fiber, or different fiber types), provided they operate at the same speed.

Aggregated Links can be assigned manually (**Port Trunk**) or automatically by enabling Link Aggregation Control Protocol (**LACP**) on the relevant links.

Aggregated Links are treated by the system as a single logical port. Specifically, the Aggregated Link has similar port attributes to a non-aggregated port, including auto-negotiation, speed, Duplex setting, etc.

The device supports the following Aggregation links :

- **Static LAGs (Port Trunk)** – Force aggregated selected ports to be a trunk group.
- **Link Aggregation Control Protocol (LACP) LAGs** - LACP LAG negotiate Aggregated Port links with other LACP ports located on a different device. If the other device ports are also LACP ports, the devices establish a LAG between them.

4.8.1 Port Trunk

This function provides to cascade two Switch devices with a double bandwidth (maximum up to 1.6/2.4Gbps in full duplex mode).

- Eight Trunk Group per system
- For GSW-1602SF, up to 8 ports per Trunk Group
- For GSW-2404SF / GSW-2416SF, up to 12 ports per Trunk Group

The Port Trunking configuration screen in Figure 4-30 appears.

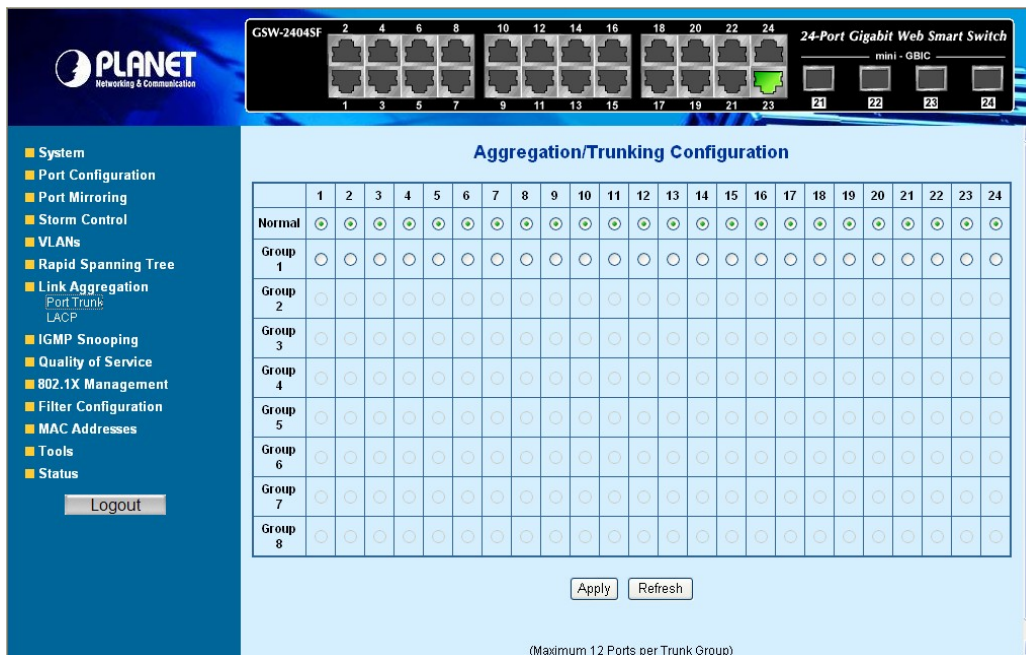

Figure 4-30 Aggregation/Trunking Configuration screen

The page includes the following fields: table 4-13 description of the Aggregation/Trunking Configuration.

• Item	Description
• Port	Indicate port 1 to port 24.
• Normal	While a port is checked as “Normal”, the port is not joining to any Static Trunk Group.
• Group	Specify the Joined Trunk Group. There're maximum eight trunk groups per system. With different switch model, the maximum number of ports are as follow: GSW-1602SF – Up to 8 ports per Trunk Group GSW-2404SF – Up to 12 ports per Trunk Group A port can be assigned to only one Trunk Group.

Table 4-13 Description of the Aggregation/Trunking Configuration

4.8.2 LACP

Link Aggregation Control Protocol (LACP) - **LACP** LAG negotiate Aggregated Port links with other **LACP** ports located on a different device. If the other device ports are also **LACP** ports, the devices establish a LAG between them.

The **LACP** Port Configuration page contains fields for assigning **LACP** properties to individual ports. The screen in Figure 4-31 appears.

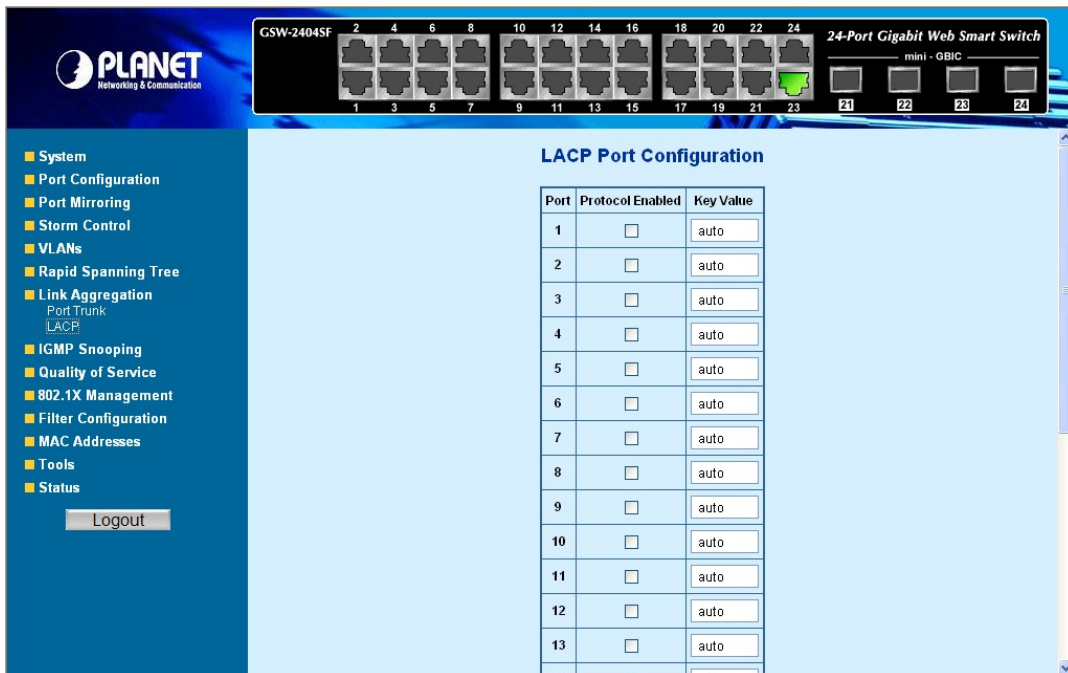

Figure 4-31 LACP Port Configuration

The page includes the following fields: table 4-14 description of the LACP Port Configuration.

• Item	Description
• Port	Indicate port 1 to port 24.
• Protocol Enable	To Enable or disable the LCAP protocol on a selected port. Once the LACP protocol be enabled, the system will start transmit the LACP control packets and exchange with another LACP aware switch. If the linked switch didn't support LACP, then the aggregated link will not be established.
• Key Value	<p>The Key Value will be filed in the LACP control packets. Ports with same key value will be set to the same LACP Group. If two ports are set with different key value, they will become two different LCAP groups. The key value will also be the identify ID to the linked LACP switch.</p> <p>The default setting is "Auto"</p>

Table 4-14 Description of the LACP Port Configuration.

 **Note:**

When using a port link aggregation, note that:

- The ports that can be assigned to the same link aggregation have certain other restrictions (see below).
 - Ports can only be assigned to one link aggregation.
 - The ports at both ends of a connection must be configured as link aggregation ports.
 - None of the ports in a link aggregation can be configured as a mirror source port or a mirror target port.
 - All of the ports in a link aggregation have to be treated as a whole when moved from/to, added or deleted from a VLAN.
 - The Spanning Tree Protocol will treat all the ports in a link aggregation as a whole.
 - Disconnect all link aggregation port cables or disable the link aggregation ports before removing a port link aggregation to avoid creating a data loop.
-

4.8.3 LACP Status

The LACP Status page display the current LACP aggregation Groups and LACP Port status.

To open **LACP Status** screen perform the folling:

1. Click Status -> LACP Status
2. The “LACP Aggregation Overview” and “LACP Port Status” screen is displayed as in Figure 4-32.

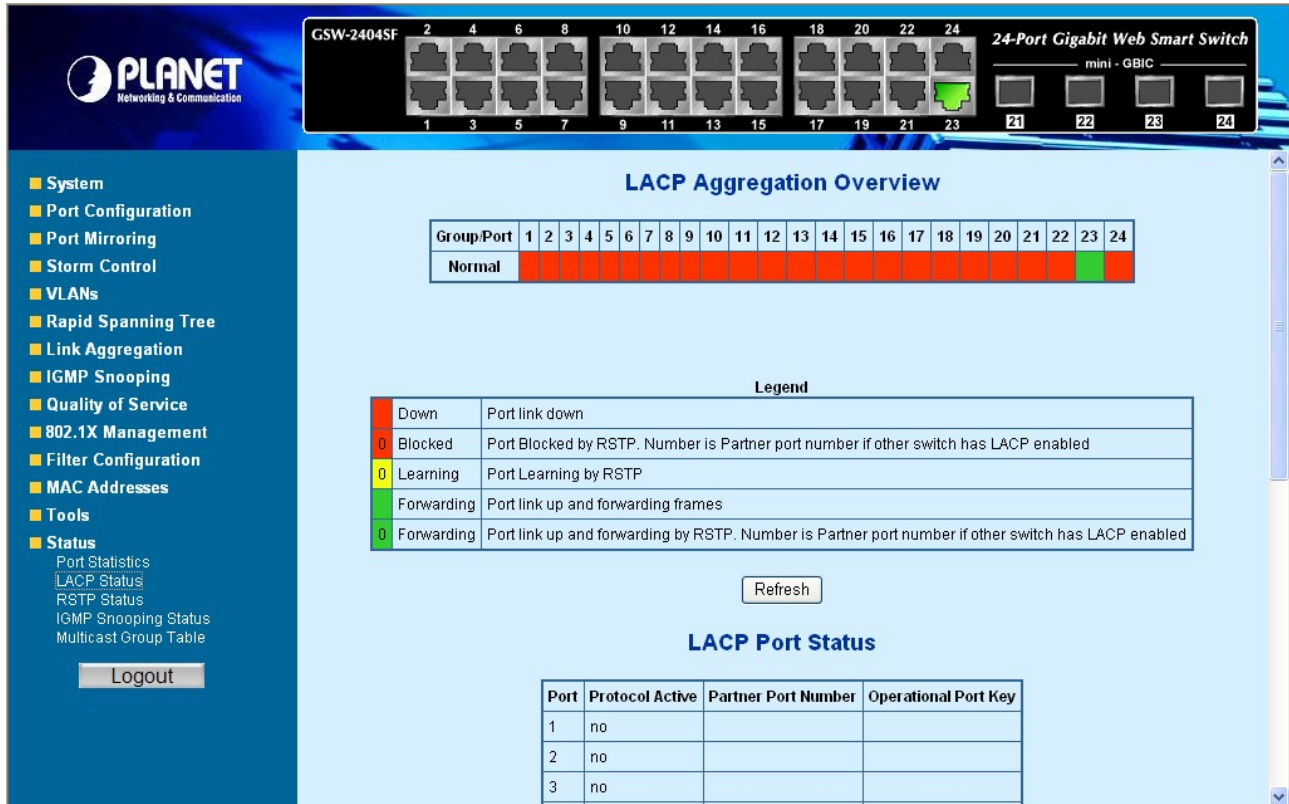

Figure 4-32 LACP Status

■ **LACP Aggregation Overview Table**

The LACP Aggregation Overview Table lists the active LACP ports and mapped Group. It also indicates the Partner Port number of the other LACP aware switches. The screen in Figure 4-33 appears.



Figure 4-33 LACP Aggregation Overview

The page includes the following fields: table 4-15 description of the LACP Aggregation Overview.

Item	Description
Group / Port	Indicate port 1 to port 24.
Normal	While a port is checked as "Normal", the port is not joining to any LACP Trunk Group.
Group #	The Linked LACP aggregation group. The Group ID is the first port ID of the LACP group member. ex. Port 7 and Port 8 as a LACP group-> Group 7; Port 23 and Port 24 as a LACP group-> Group 23

Table 4-15 Description of the LACP Aggregation Overview

The Color and ID legend

0	Down	Port link down
0	Blocked	Port Blocked by RSTP. Number is Partner port number if other switch has LACP enabled
0	Learning	Port Learning by RSTP
0	Forwarding	Port link up and forwarding frames
0	Forwarding	Port link up and forwarding by RSTP. Number is Partner port number if other switch has LACP enabled

■ **LACP Port Status Table**

The LACP Port Status Table lists the active LACP ports and the Partner Port number with the operational Port Key value. The screen in Figure 4-34 appears.

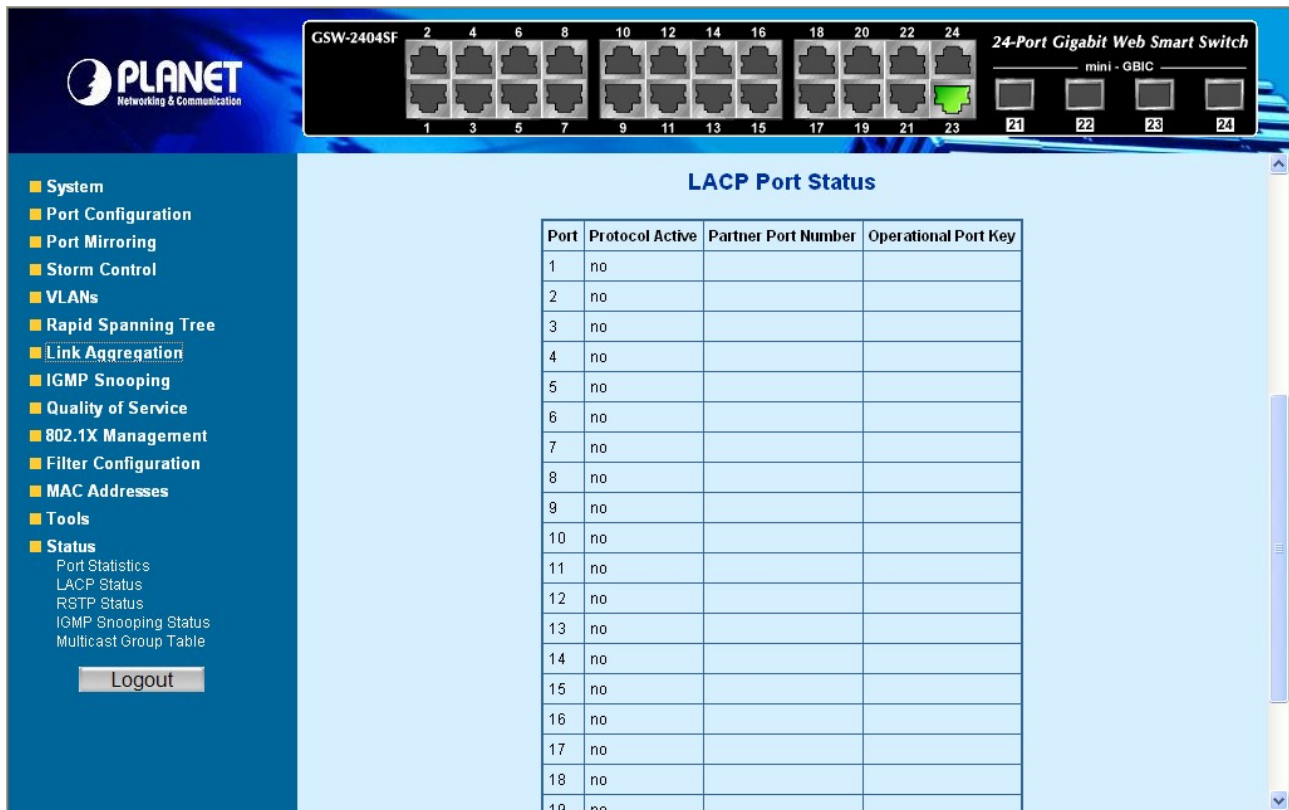

Figure-4-34 LACP Port Status

The page includes the following fields: table 4-16 description of the LACP Port Status.

• Item	Description
• Port	Indicate port 1 to port 24.
• Protocol Active	Indicate the LCAP protocol is enable or not on the port. Yes- LACP is enabled and active on the port No- LACP is not enabled, or LACP is enabled but not active on the port. It's usually depends on the partner switch is LACP enabled or not.
• Partner Port Number	The port number/ID of the linked partner switch- if other switch has LACP enabled. Ex. Row of Port 7with Partner Port Number value=15 The Port 7 of the switch is connecting to the Port 15 of the partner switch directly – both of the two switches are with LACP enabled.
• Operational Port Key	The current operational key value of the partner port. Within the same LACP group, the port key value should be the same with the other LACP active ports.

Table 4-16 Description of the LACP Port Status

4.9 IGMP Snooping

The Internet Group Management Protocol (IGMP) lets host and routers share information about multicast groups memberships. IGMP snooping is a switch feature that monitors the exchange of IGMP messages and copies them to the CPU for feature processing. The overall purpose of IGMP Snooping is to limit the forwarding of multicast frames to only ports that are a member of the multicast group.

4.9.1 IGMP Snooping Configuration

The IGMP Configuration page let the administrator to configure the parameters for IGMP Snooping, which is used to build forwarding lists for multicast traffic. The screen in Figure 4-35 appears.

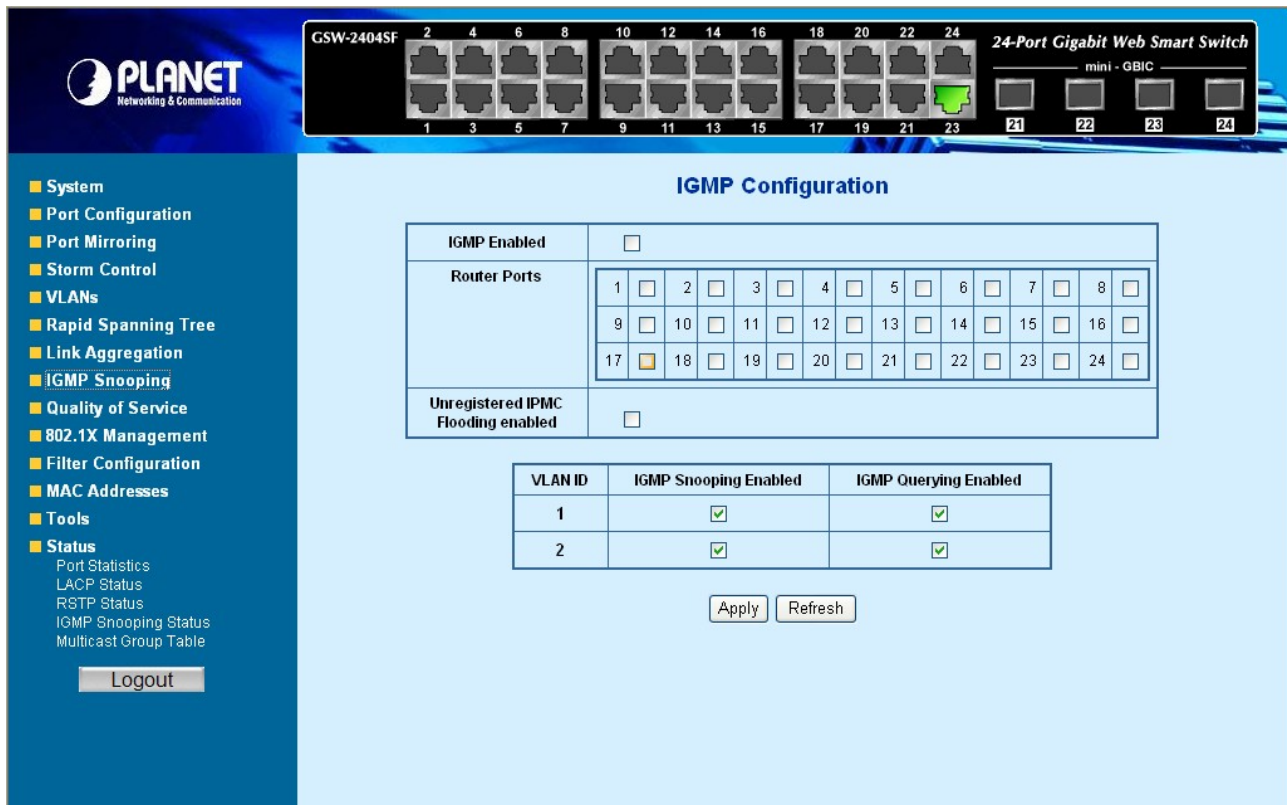

Figure 4-35 IGMP Snooping Configuration and Status

The page includes the following fields: table 4-17 description of the **IGMP** Snooping Configuration.

• Item	Description
• IGMP Enable	Enables or disables IGMP global function on the device. Disabled is the default value.
• Router Ports	The Router Ports check box fields for attaching ports to a device that is attached to a neighboring Multicast router/switch. Once IGMP Snooping is enabled, Multicast packets are forwarded to the appropriate port .
• Unregistered IPMC Flooding Enable	The function is to set “Enable” or “Disable” to allow the unregistered IP Multicast Group streams to flood to all ports of this switch. The unregistered IP Multicast means that the received Multicast Group address not listed in the Multicast Group Table of the switch. Enabled is the default value. The switch forwards all the multicast steams to all the host or linked switch.
• VLAN ID	Identifies a VLAN and contains information about the Multicast group

	configuration. Add a new VLAN group and the Table will add the VLAN entry automatically.
• IGMP Snooping Enabled	Enables or disables IGMP snooping on the VLAN. Ports be assign to the VLAN will be applied to filter the Multicast stream. Enabled is the default value.
• IGMP Querying Enabled	Enables or disables IGMP Query mode on the VLAN. The Query mode is used to periodically check the multicast group for members that are no longer active. In the case where there is more than one multicast router on a sub network, one router is elected as the 'queried'. This router then keeps track of the membership of the multicast groups that have active members. The information received from IGMP is then used to determine if multicast packets should be forwarded to a given sub network or not. The router can check, using IGMP, to see if there is at least one member of a multicast group on a given subnet work. If there are no members on a sub network, packets will not be forwarded to that sub network. Enabled is the default value.

Table 4-17 Description of the IGMP Snooping Configuration

Note: Add a new VLAN group, the VLAN ID will be added to the table automatically with both “**IGMP Snooping Enabled**” and “**IGMP Querying Enabled**”

4.9.2 IGMP Snooping Status

The IGMP Snooping page display the current IGMP Status and the statistics of received Query / report packets.

To open **IGMP Status** screen perform the folling:

1. Click Status -> **IGMP Snooping Status**
2. The “IGMP Status” screen is displayed as in Figure 4-36.

The screenshot shows the IGMP Status page for a Planet GSW-2404SF switch. The page includes a navigation menu on the left with options like System, Port Configuration, VLANs, and Status. The main content area displays the IGMP Status for two VLANs. The table below shows the status for VLAN 1 and VLAN 2.

VLAN ID	Querier	Queries transmitted	Queries received	v1 Reports	v2 Reports	v3 Reports	v2 Leaves
1	Idle	0	0	0	0	0	0
2	Idle	0	0	0	0	0	0

Below the table is a 'Refresh' button.

Figure 4-36 IGMP Snooping Status

The page includes the following fields: table 4-18 description of the **IGMP** Snooping Status.

• Item	Description
• VLAN ID	Identifies a VLAN and contains information about the Multicast group configuration.
• Querier	<p>Display the current status of IGMP Querier on the device.</p> <p>Active – The IGMP Query function had been enabled on the device and played as a main Querier within a subnet domain. Within a network domain, there will be only one IGMP Querier. While two or more Querier exist, only one Querier operation by election. The Querier will transmit a IGMP Query packet about every 125 secs.</p> <p>Idle – The IGMP Querier function had be enabled but might be at the initiation status, or there're already other Querier exist.</p>
• Queries transmitted	Statistics of IGMP Query packets transmitted from the VLAN. Only the "IGMP Querying Enabled" be checked, the counter is active.
• Queries received	Statistics of IGMP Query packets received at the VLAN –from another switches or routers.
• V1 Reports	<p>Statistics of IGMP V1 report packets received at the VLAN.</p> <p>(Packets with content type = 0x12 ; The Membership Report (version 1))</p>
• V2 Reports	<p>Statistics of IGMP V2 report packets received at the VLAN.</p> <p>(Packets with content type = 0x16 ; The Membership Report (version 2))</p>
• V3 Reports	Statistics of IGMP V3 report packets received at the VLAN.
• V2 Leaves	<p>Statistics of IGMP V2 leave packets received at the VLAN.</p> <p>(Packets with content type = 0x17 ; Leave a Group (version 2))</p>

Table 4-18 Description of the **IGMP** Snooping Status

4.9.3 Multicast Group Table

The Multicast Group page displays the ports attached to the Multicast service group in the Ports tables. The Port a tables also reflect the manner in which the port joined the Multicast group. Ports can be added either to existing groups or to new Multicast service groups. The Bridge Multicast Group page permits new Multicast service groups to be created. The Bridge Multicast Group page also assigns ports to a specific Multicast service address group.

To open **Multicast Group Tables** screen perform the folling:

1. Click Status -> Multicast Group Table
2. The Multicast Group Table screen is displayed as in Figure 4-37.

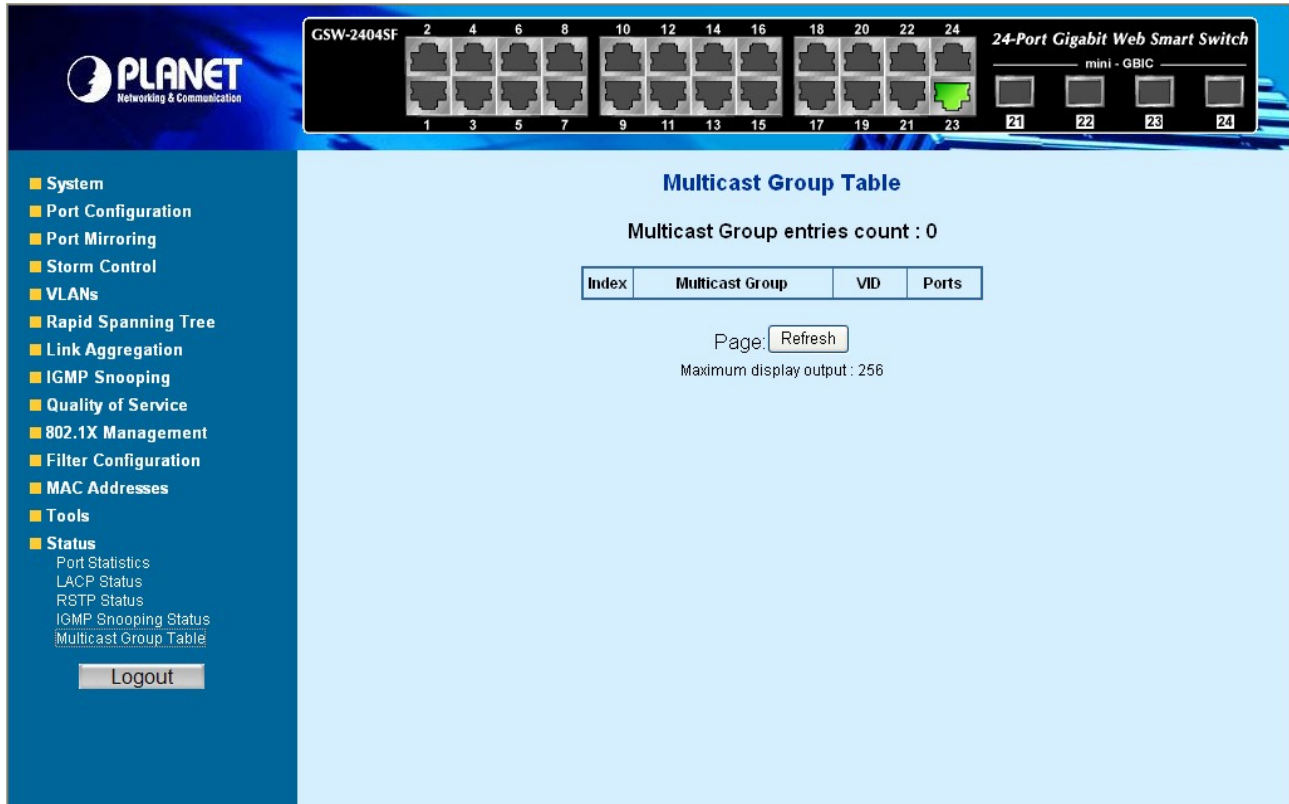

Figure 4-37 The Multicast Group Table screen

The page includes the following fields: table 4-19 description of the Multicast Group Table.

• Item	Description
• Multicast Group entries Count	The total count of the current Multicast Group entries of the Switch.
• Multicast Group	Identifies the Multicast group MAC address/IP address
• VID	Identifies a VLAN and contains information about the Multicast group address.
• Ports	Identifies assigned ports to a specific Multicast service address group- By received Join or leave packets.

Table 4-19 Description of the Multicast Group Table

4.10 Quality of Service

Quality of Service (QoS) is an advanced traffic prioritization feature that allows you to establish control over network traffic. QoS enables you to assign various grades of network service to different types of traffic, such as multi-media, video, protocol-specific, time critical, and file-backup traffic.

QoS reduces bandwidth limitations, delay, loss, and jitter. It also provides increased reliability for delivery of your data and allows you to prioritize certain applications across your network. You can define exactly how you want the switch to treat selected applications and types of traffic.

You can use QoS on your system to:

- Classifying traffic based on packet attributes.
- Assigning priorities to traffic (for example, to set higher priorities to time-critical or business-critical applications).
- Applying security policy through traffic filtering.
- Provide predictable throughput for multimedia applications such as video conferencing or voice over IP by minimizing delay and jitter.
- Improve performance for specific types of traffic and preserve performance as the amount of traffic grows.
- Reduce the need to constantly add bandwidth to the network.
- Manage network congestion.

The **QoS Configuration** page contains fields for enabling or disabling QoS. In addition, the 802.1p mode or DSCP mode can be selected. Both the two mode rely on predefined fields within the packet to determine the output queue.

- **QoS Disabled** - Disables managing network traffic using Quality of Service.
- **802.1p Mode** –The output queue assignment is determined by the IEEE802.1p VLAN priority tag.
- **DSCP Mode** - The output queue assignment is determined by the DSCP field.

 **Note:** The current version of GSW-1602SF/GSW-2404SF/GSW-2416SF support QoS **Strict** mode only. The strict mode is to specifies if traffic scheduling is based strictly on the queue priority.

The QoS Configuration page in Figure 4-38 appears.

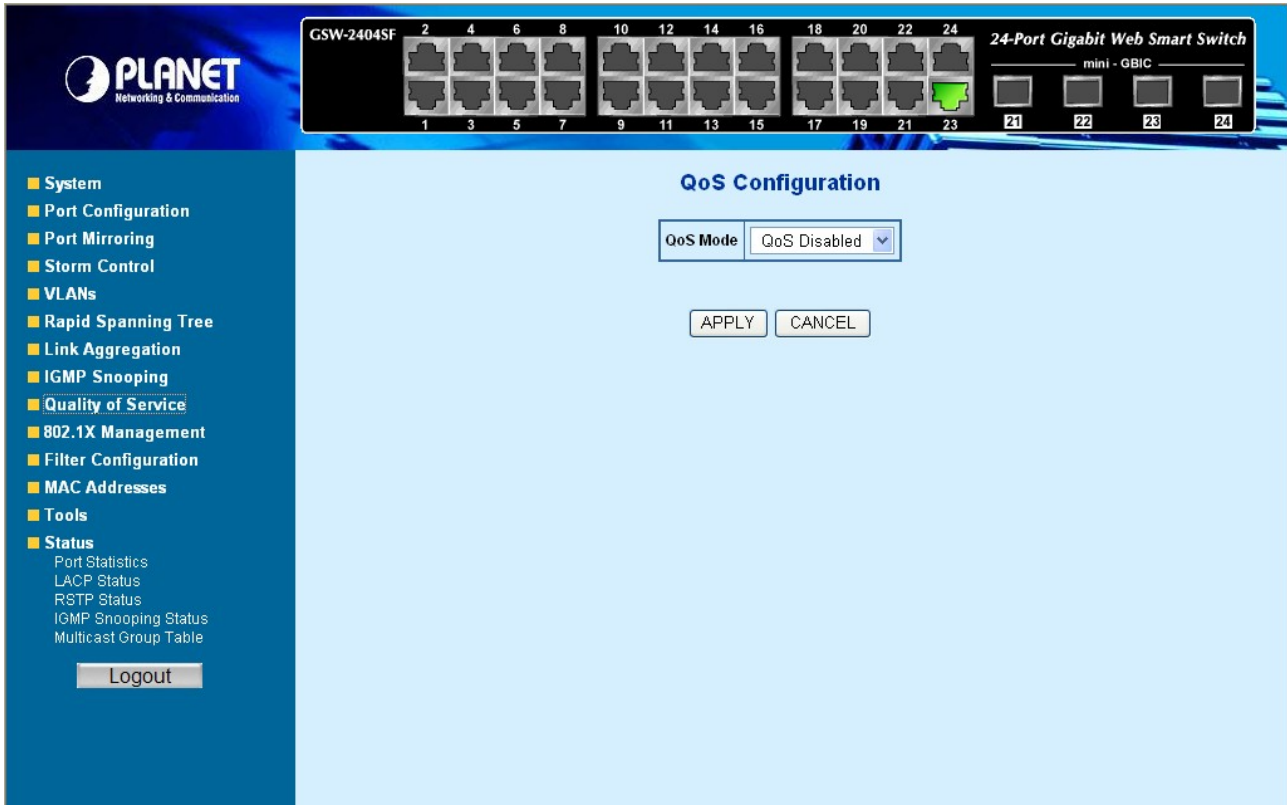

Figure 4-38 QoS Configuration screen

4.10.1 802.1p QoS Mode

QoS settings allow customization of packet priority in order to facilitate delivery of data traffic that might be affected by latency problems. The IEEE 802.1p Priority specification uses 8 priority levels to classify data packets. The screen in Figure 4-39 and Figure 4-40 appears.

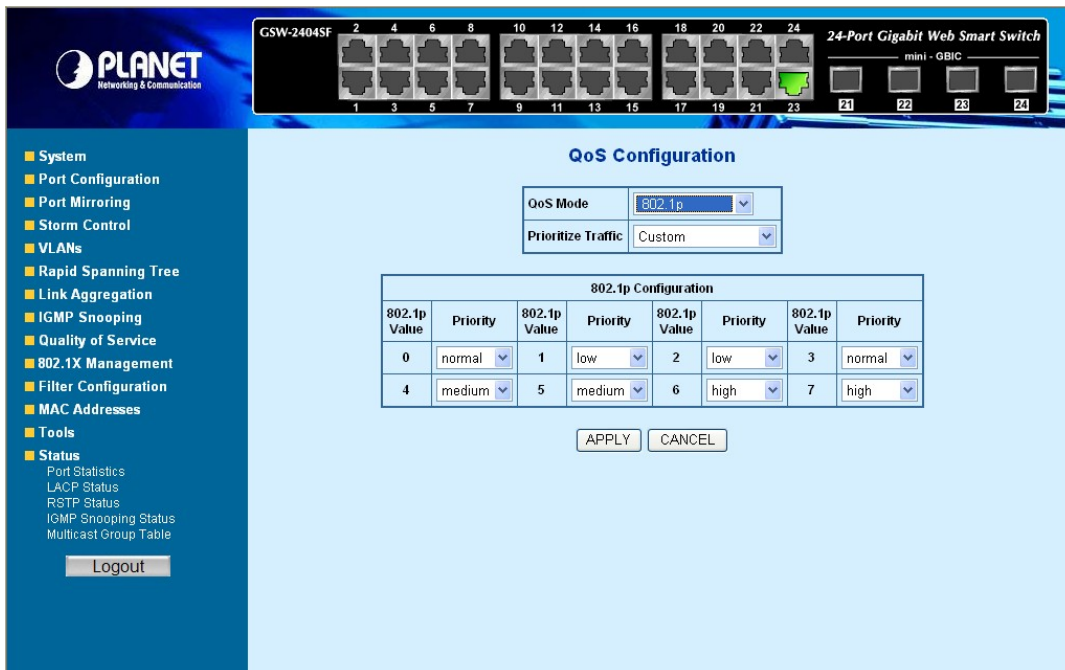

Figure 4-39 802.1p QoS Configuration screen

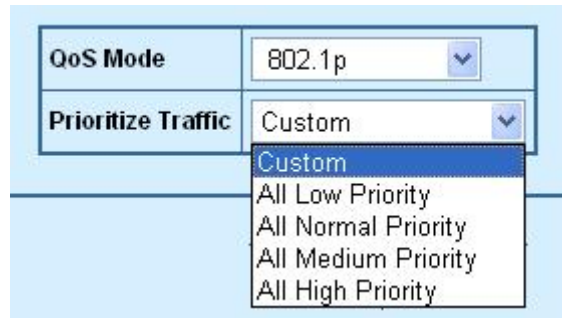

Figure 4-40 Prioritize Traffic screen

The page includes the following fields: Table 4-20 Description of the QoS Configuration.

• Item	Description
<ul style="list-style-type: none"> • Prioritize Traffic 	<p>The draw menu allows customization of 802.1p to Traffic classifiers. Total 5 selections for the Prioritize Traffic.</p> <ul style="list-style-type: none"> • Custom – Manual mapping the 802.1p priority to the 4-level queues. Setup at the next table. • All Low Priority - mapping all 802.1p tagged packets to Queue 0 • All Normal Priority - mapping all 802.1p tagged packets to Queue 1 • All Medium Priority - mapping all 802.1p tagged packets to Queue 2 • All High Priority - mapping all 802.1p tagged packets to Queue 3
<ul style="list-style-type: none"> • 802.1p Value 	<p>Specifies the CoS priority tag values, where zero is the lowest and 7 is the highest.</p>
<ul style="list-style-type: none"> • Priority 	<p>The traffic forwarding queue to which the CoS priority is mapped. Four traffic priority queues are supported as follow :</p> <ul style="list-style-type: none"> • Low = Queue 0 • Normal = Queue 1 • Medium = Queue 2 • High = Queue 3

Table 4-20 Description of the QoS Configuration

4.10.2 DSCP QoS Mode

DiffServ Code Point (DSCP) – is the traffic prioritization bits within an IP header that are encoded by certain applications and/or devices to indicate the level of service required by the packet across a network.

The **DSCP Configuration** page provides fields for defining output queue to specific DSCP fields.

Select the QoS mode to DSCP, the DSCP to queue mapping configuration page appears, as the Figure 4-41 shows.

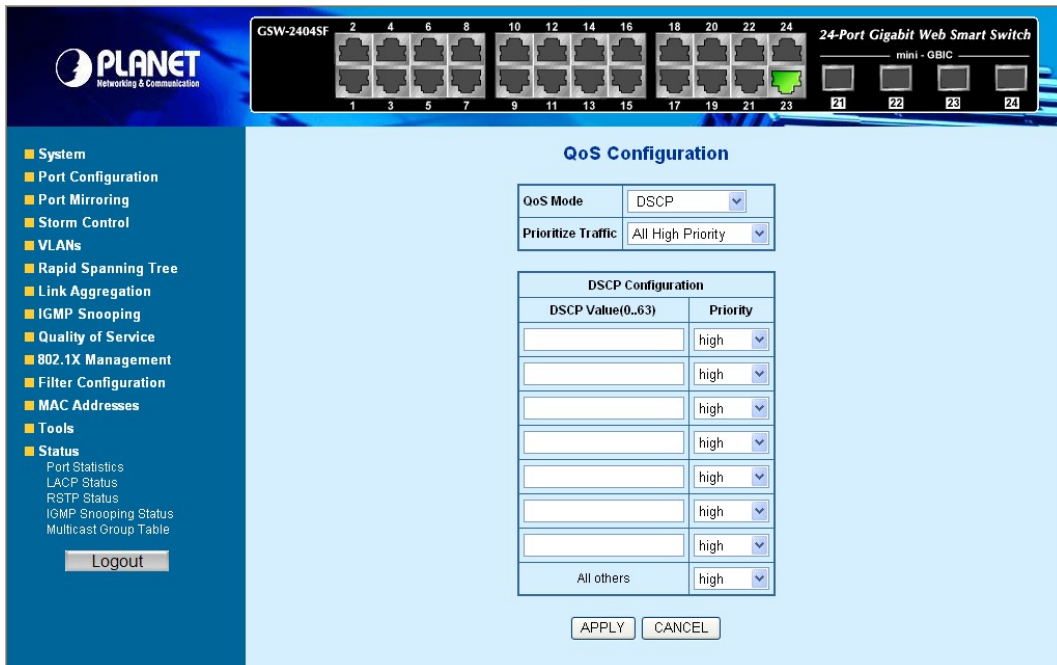

Figure 4-41 DSCP QoS Configuration screen

The page includes the following fields: Table 4-21 Description of the DSCP QoS Configuration.

• Item	Description
• Prioritize Traffic	<p>The draw menu allows customization of DSCP to Traffic classifiers. Total 5 selections for the Prioritize Traffic.</p> <ul style="list-style-type: none"> • Custom – Manual mapping the DSCP to the 4-level queues. Setup at the next table. • All Low Priority - mapping all IP DCSP header packets to Queue 0 • All Normal Priority - mapping all IP DCSP header packets to Queue 1 • All Medium Priority - mapping all IP DCSP header packets to Queue 2 • All High Priority - mapping all IP DCSP header packets to Queue 3
• DSCP Value (0..63)	<p>The values of the IP DSCP header field within the incoming packet.</p>
• Priority	<p>The traffic forwarding queue to which the DSCP is mapped. Four traffic priority queues are supported.</p> <p>The queue to which packets with the specific DSCP value is assigned. The values are low,Normal,Medium and High.</p> <ul style="list-style-type: none"> • Low = Queue 0 • Normal = Queue 1 • Medium = Queue 2 • High = Queue 3

Table 4-21 Description of the DSCP QoS Configuration

4.11 802.1X Management

The PALENT GSW-1602SF/GSW-2404SF/GSW-2416SF supports IEEE 802.1X Port-based network access control and RADIUS server authentication to enhance the host link more security. An 802.1X Infrastructure is composed of three major components: Authenticator, Authentication server, and Supplicant.

Authentication server – (RADIUS Server): An entity that provides an authentication service to an authenticator. This service determines, from the credentials provided by the supplicant, whether the supplicant is authorized to access the services provided by the authenticator.

Authenticator-(GSW-1602SF/GSW-2404SF/GSW-2416SF): An entity at one end of a point-to-point LAN segment that facilitates authentication of the entity attached to the other end of that link.

Supplicant-(A Host Client): An entity at one end of a point-to-point LAN segment that is being authenticated by an authenticator attached to the other end of that link.

The instructions are divided into three parts:

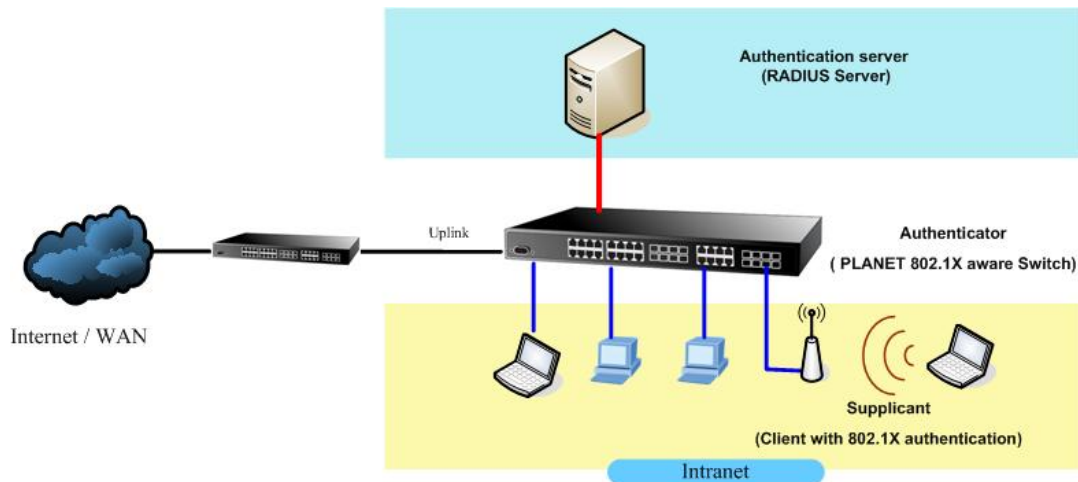

The above graph shows the network topology of the solution we are going to introduce. As illustrated, a group of clients is trying to build a network with GSW-1602SF/GSW-2404SF/GSW-2416SF in order to have access to both Internet and Intranet. With 802.1X authentication, each of these clients would have to be authenticated by RADIUS server. If the client is authorized, GSW-1602SF/GSW-2404SF/GSW-2416SF would be notified to open up a communication port to be used for the client. There are 2 Extensive Authentication Protocol (EAP) methods supported: (1) MD5 and (2) TLS.

MD5 authentication is simply a validation of existing user account and password that is stored in a database of RADIUS server. Therefore, clients will be prompted for account/password validation to build the link. TLS authentication is a more complicated authentication, which is using certificate that is issued by RADIUS server for authentication. TLS authentication is a more secure authentication, since not only RADIUS server authenticates the client, but also the client can validate RADIUS server by the certificate that it issues. The TLS authentication request from clients and reply by Radius Server and GSW-1602SF/GSW-2404SF/GSW-2416SF can be briefed as follows:

1. The client sends an EAP start message to Web-Smart Switch.
2. Web-Smart Switch replies with an EAP Request ID message.
3. The client sends its Network Access Identifier (NAI) – its user name – to Web-Smart Switch in an EAP Respond message.
4. Web-Smart Switch forwards the NAI to the RADIUS server with a RADIUS Access Request message.
5. The RADIUS server responds to the client with its digital certificate.
6. The client validates the digital certificate, and replies its own digital certificate to the RADIUS server.
7. The RADIUS server validates client's digital certificate.
8. The client and RADIUS server derive encryption keys.

9. The RADIUS server sends Web-Smart Switch a RADIUS ACCEPT message.

10. Web-Smart Switch sends the client an EAP Success message along with the broadcast key and key length.

This section is to control the access of the switch, includes the user access and management control. The 802.1X Management page contains links to the following topics:

- RADIUS Server Configuration
- Port Access Control

4.11.1 RADIUS Server Configuration

This page is to configure the RADIUS server connection features. The screen in Figure 4-42 and Figure 4-43 appears.

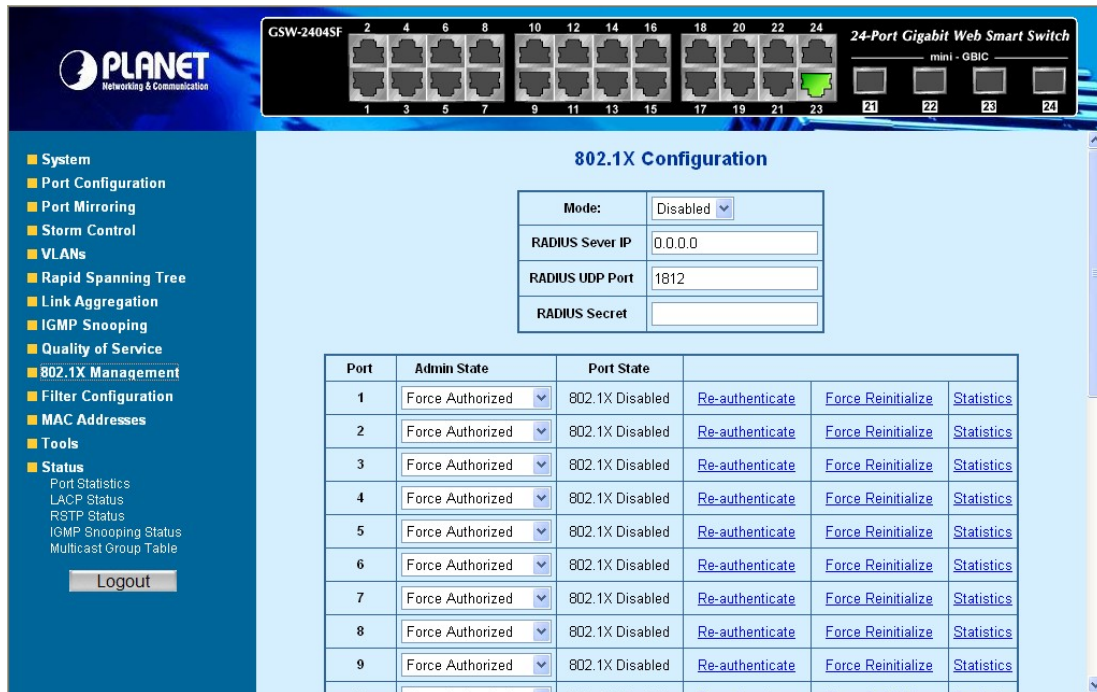

Figure 4-42 802.1X Configuration screen

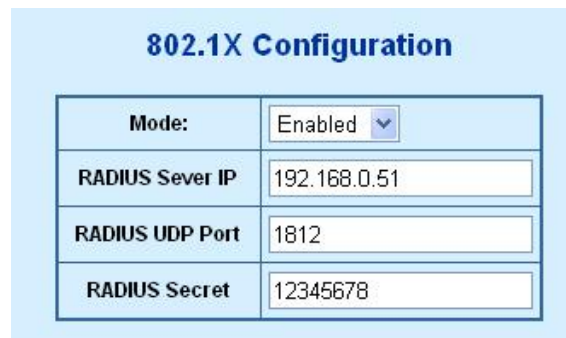

Figure 4-43 RADIUS Server configuration table screen

The RADIUS Server configuration table includes the following fields: Table 4-22 Description of the 802.1X Configuration.

• Item	Description
• Mode	To Enable/Disable the port access control administrative mode This selector lists the two options for administrative mode: enable and disable. The default value is disabled ..
• RADIUS Server IP	The IP address of the RADIUS server being added.
• RADIUS UDP Port	The UDP port used by this server. The valid range is 0 - 65535. The default UDP Port No. is 1812
• RADIUS Secret	Indicates if the shared secret for this server has been configured.

Table 4-22 Description of the 802.1X Configuration

Setup the RADIUS server and assign the client IP address to the Web-Smart switch. In this case, field in the default IP Address of the Web-Smart switch with 192.168.0.100. And also make sure the shared secret key is as same as the one you had set at the switch RADIUS server – 12345678 at this case.

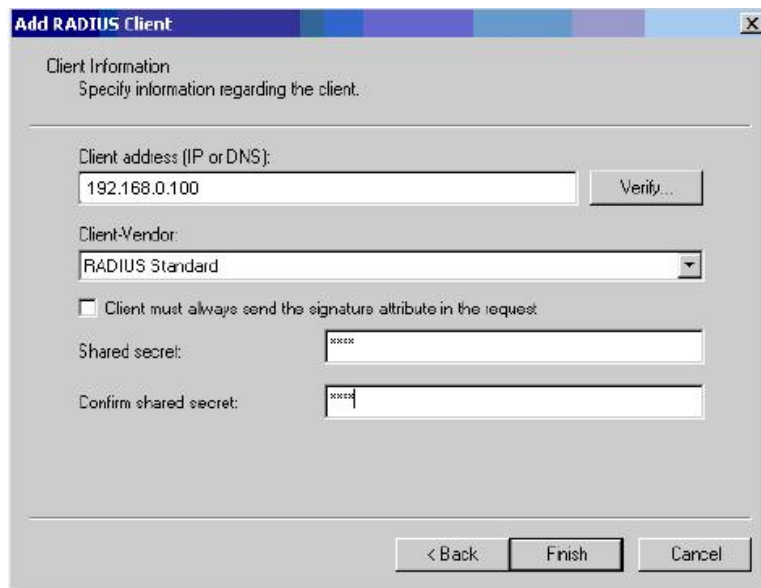

Figure 4-44 RADIUS Server configuration

4.11.2 Port Access Control

This table is to configure the per port network access control setting. By drawing and select the menu bar to define the port control type. The screen in Figure 4-45 and Figure 4-46 appears.

Port	Admin State	Port State			
1	Force Authorized	802.1X Disabled	Re-authenticate	Force Reinitialize	Statistics
2	Force Authorized	802.1X Disabled	Re-authenticate	Force Reinitialize	Statistics
3	Force Authorized	802.1X Disabled	Re-authenticate	Force Reinitialize	Statistics
4	Force Authorized	802.1X Disabled	Re-authenticate	Force Reinitialize	Statistics
5	Force Authorized	802.1X Disabled	Re-authenticate	Force Reinitialize	Statistics
6	Force Authorized	802.1X Disabled	Re-authenticate	Force Reinitialize	Statistics
7	Force Authorized	802.1X Disabled	Re-authenticate	Force Reinitialize	Statistics
8	Force Authorized	802.1X Disabled	Re-authenticate	Force Reinitialize	Statistics
9	Force Authorized	802.1X Disabled	Re-authenticate	Force Reinitialize	Statistics
10	Force Authorized	802.1X Disabled	Re-authenticate	Force Reinitialize	Statistics

Figure 4-45 Per Port network access control configure table

Port	Admin State
1	Force Authorized
2	Auto
3	Force Authorized
	Force Unauthorized

Figure 4-46 802.1X Network access control mode selection

The Network Access Control port configuration table includes the following fields: Table 4-23 Description of the Port Access Control.

• Item	Description
• Port	Selects the port to be configured. When the selection is changed, a screen refresh will occur causing all fields to be updated for the newly selected port.
• Admin State	This selector lists the options for control mode. The control mode is only set if the link status of the port is link up. The options are: <ul style="list-style-type: none"> • Auto: The authenticator PAE sets the controlled port mode to reflect the outcome of the authentication exchanges between the supplicant, authenticator, and the authentication server. • Force authorized: The authenticator PAE unconditionally sets the controlled port to be authorized. • Force unauthorized: The authenticator port access entity (PAE) unconditionally sets the controlled port to unauthorized
• Port State	This field indicates the configured control mode for the port.
• Re-authenticate	This button begins the re-authentication sequence on the selected port. This button is only selectable if the control mode is 'auto'. If the button is not selectable,

	it will be grayed out. Once this button is pressed, the action is immediate. It is not required to press the Submit button for the action to occur.
• Force Reinitialize	This button begins the re-initialization sequence on the selected port. This button is only selectable if the control mode is 'auto'. If the button is not selectable, it will be grayed out. Once this button is pressed, the action is immediate. It is not required to press the Submit button for the action to occur.
• Statistics	This button redirect to the “802.1X Statistics” page on the selected port.
• Re-authenticate All	This button begins the re-authentication sequence on the all ports.
• Force Reinitialize All	This button begins the re-initialization sequence on all ports.

Table 4-23 Description of the Port Access Control

At the bottom of this page, click “**Parameter**” button will redirect to the “**802.1X parameter**” configure page. The screen in Figure 4-47 appears.

Figure 4-47 802.1X Parameter configuration screen

The 802.1X Parameters table includes the following fields: Table 4-24 Description of the 802.1X Parameter.

• Item	Description
• Reauthentication Enabled	This select field allows the user to enable or disable reauthentication of the supplicant for the specified port. If “Enabled” be checked, reauthentication will occur. Otherwise, reauthentication will not be allowed. Changing the selection will not change the configuration until the Apply button is pressed. The default value is not “Enabled”
• Reauthentication Period [1-3600 seconds]	This input field allows the user to enter the reauthentication period for the selected port. The reauthentication period is the value, in seconds, of the timer used by the authenticator state machine on this port to determine when reauthentication of the supplicant takes place. The reauthentication period must be a value in the range of 1 and 65535. Changing the value will not change the configuration until the Apply button is pressed. The default value is 3600 .
• EAP Timeout [1-255 seconds]	This input field allows the user to enter the EAP timeout for the selected port. The EAP timeout is the value, in seconds, of the timer used by the authenticator state machine on this port to timeout the supplicant. The EAP timeout must be a value in the range of 1 and 255. The default value is 30 .

Table 4-24 Description of the 802.1X Parameter

4.12 Filter Configuration

The GSW-1602SF/GSW2404SF/GSW-2416SF support per-Port IP Filter function to management the IP traffic flow. With the IP Filter configuration, administrator can block the specify source IP Address range. The screen in Figure 4-48 appears.

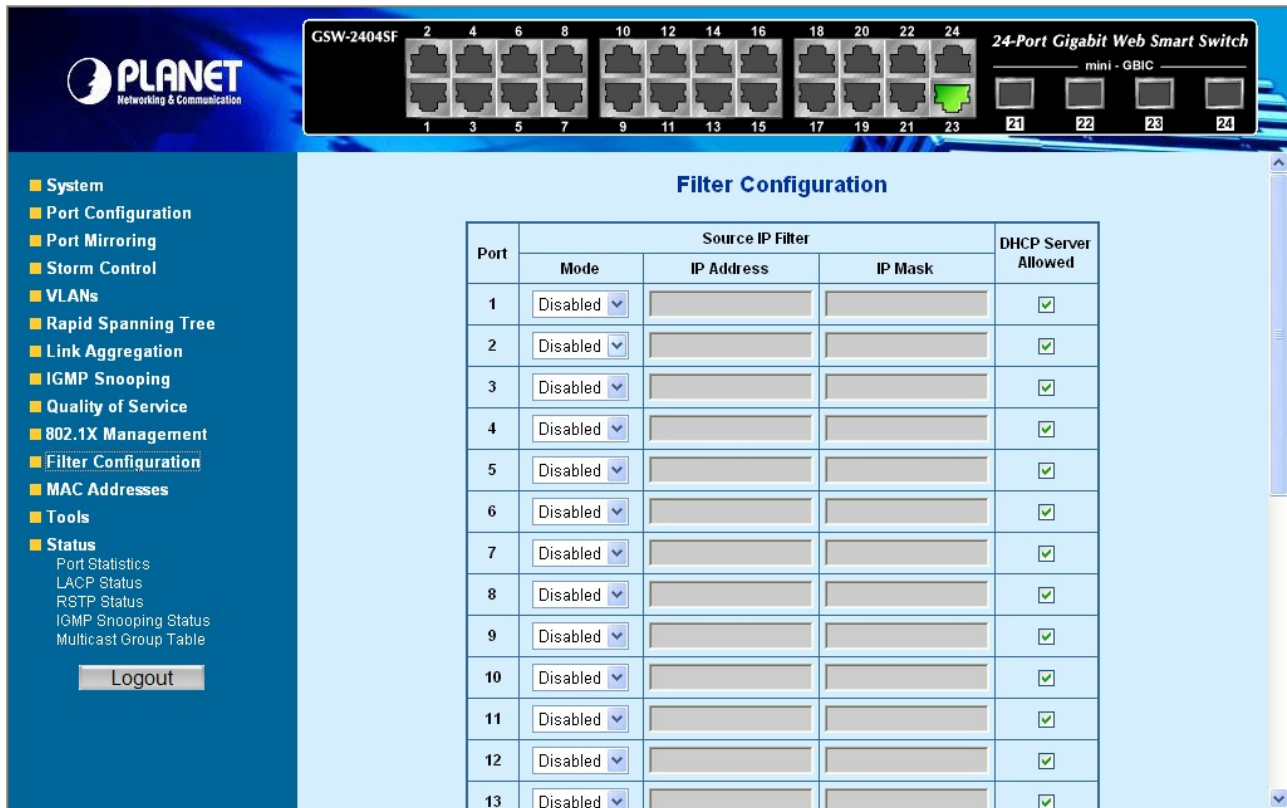

Figure 4-48 Filter Configuration screen

The Filter Configuration page includes the following fields: Table 4-25 Description of the Filter Configuration.

• Item	Description
• Port	Indicate port 1 to port 24 for the IP Filter setting.
• Mode	To “Enabled” or “Disabled” the IP Filter on the selected port. If “Enabled” be selected, the next two fields are allowed to be configured. Press “Apply” to active the IP Filter setting on the port.
• IP Address	This input field allows the user to enter the “Source IP network address” to be filtered on the selected port. This field has to co-work with the “IP Mask” filed.
• IP Mask	This input field allows the user to enter the “IP Mask” of the Source IP address to be filtered on the selected port.
• DHCP Server Allowed	To allow the ICMP DHCP request and reply packets be pass through the port even the IP address of the DHCP server inside the range of the Filter list.

Table 4-25 Description of the Filter Configuration

4.13 MAC Addresses

4.13.1 Dynamic Address Table

Use this page to set the Address Ageing Timeout for the MAC Address database, and to display information about entries in the MAC Address database. These entries are used by the transparent bridging function to determine how to forward a received frame. The screen in Figure 4-49 appears.

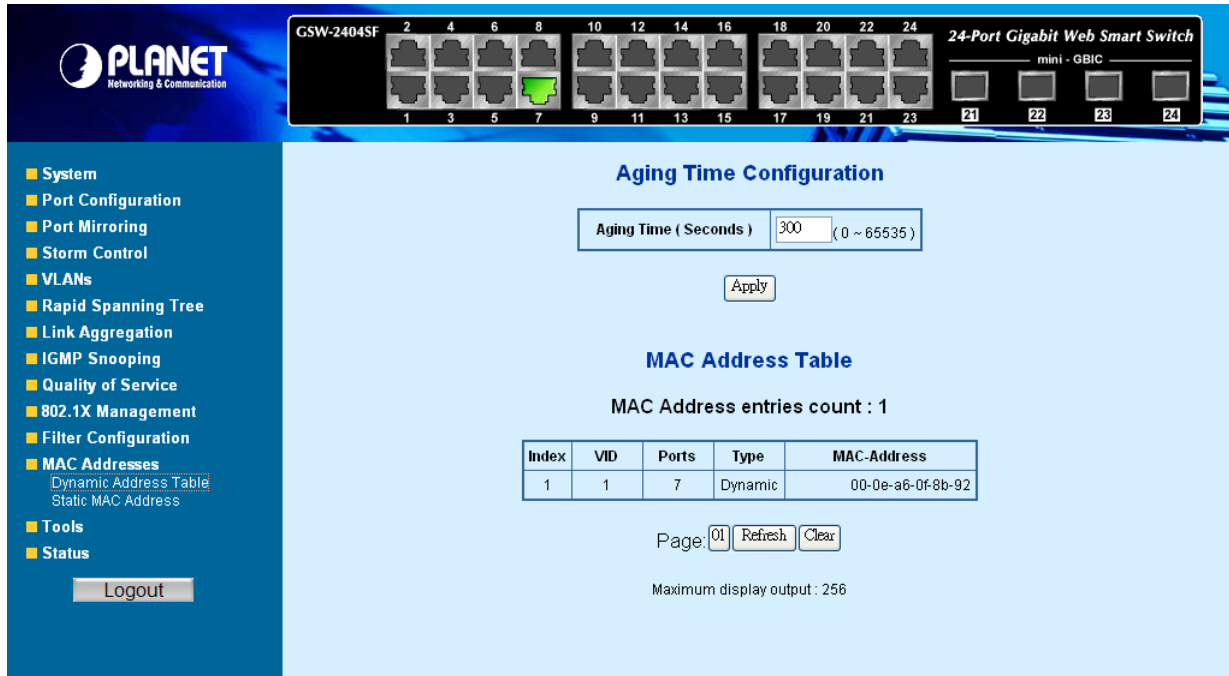

Figure 4-49 Dynamic Address Table

■ Ageing Timeout Configuration (seconds)

The MAC Address database contains static entries, which are never aged out, and dynamically learned entries, which are removed if they are not updated within a given time. You specify that time by entering a value for the Address Ageing Timeout. You may enter any number of seconds between 0 and 65535.

IEEE 802.1D recommends a default of **300** seconds, which is the factory default.

■ MAC Address Table

The MAC Address Table includes the following fields: Table 4-26 Description of the Dynamic Address Table.

Item	Description
• MAC Address entries count	The count of the MAC Address
• VID	The VLAN ID for which the table is queried.
• Ports	Specifies the port numbers for which the table is queried.
• Type	The MAC Address type for which the table is queried. There're two possible type- <ul style="list-style-type: none"> • Dynamic - Addresses are associated with ports by learning the ports from the frame source address • Static - Static addresses are manually configured. Packets received with the destinated MAC address match the port static MAC setting will be forward to the specify port.

• MAC-Address	Specifies the MAC address for which the table is queried.
----------------------	---

Table 4-26 Description of the Dynamic Address Table

Note: Although the MAC Address Table of GSW-Series Web-Smart switches are up to 8K .entries. To reduce the Web-Page memory loading, the maximum MAC lists are limited to **256** entries.

4.13.2 Static MAC Address

The Static MAC Address page contains a list of static MAC addresses. Static Address can be added and removed from the page. In addition, several MAC Addresses can be defined for a single port. The screen in Figure 4-50 appears.

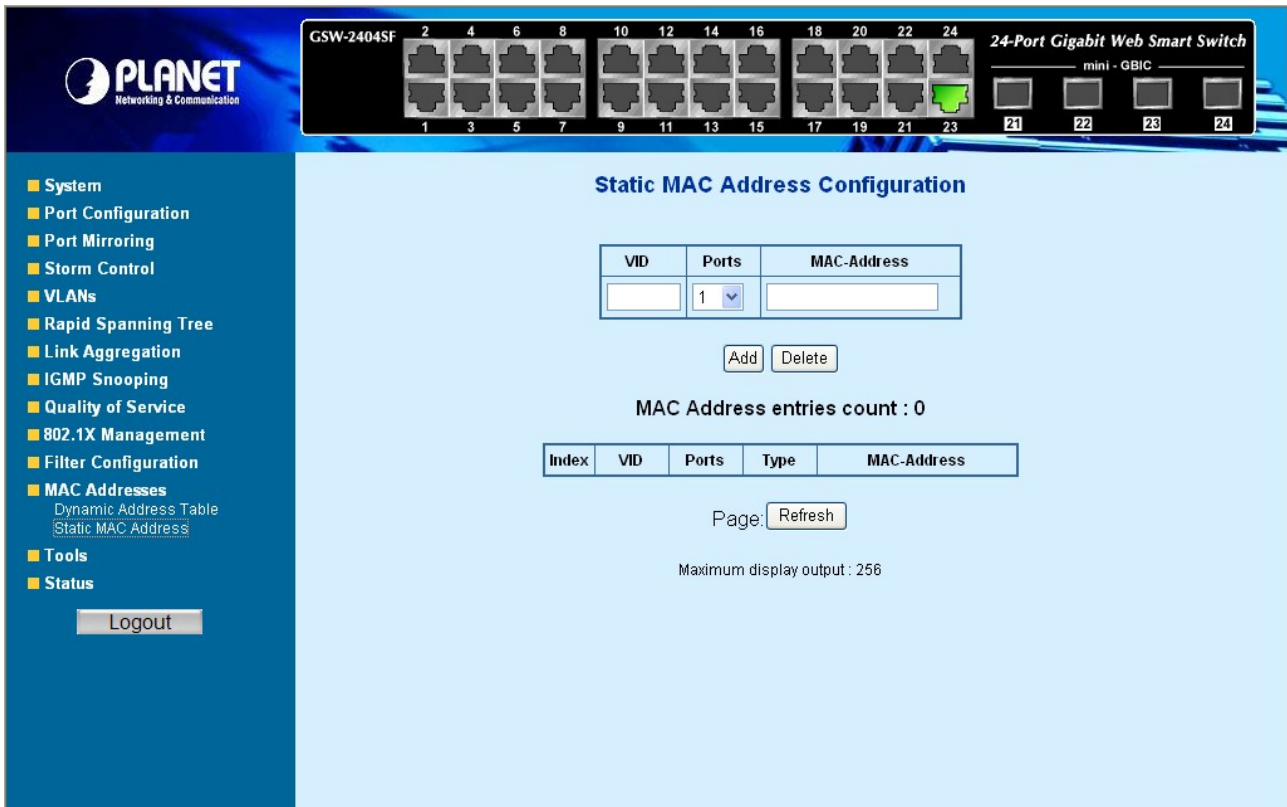

Figure-4-50 Static MAC Address Configuration

The configurable fields includes the following items: Table 4-27 Description of the Static MAC Address.

• Item	Description
• VID	The VLAN ID attached to the MAC Address
• Ports	Specifies the port numbers for which the table is queried.
• MAC-Address	Input the MAC address entry be manually bind to the specify port.

Table 4-27 Description of the Static MAC Address

The MAC Address Table includes the following fields: Table 4-28 Description of the Static MAC Address.

• Item	Description
• VID	The VLAN ID attached to the MAC Address
• Ports	Specifies the port numbers for which the table is queried.
• Type	Static - Static addresses are manually configured. Packets received with the destined MAC address match the port static MAC setting will be forward to the specify port.
• MAC-Address	The MAC address listed in the current static address list.

Table 4-28 Description of the Static MAC Address

4.14 Tools

4.14.1 Reboot

The **Reboot** page enables the device to be rebooted from a remote location. Once the Reboot button is pressed, user has to re-login the WEB interface about 20 seconds later. The Reboot screen in Figure 4-51 appears.

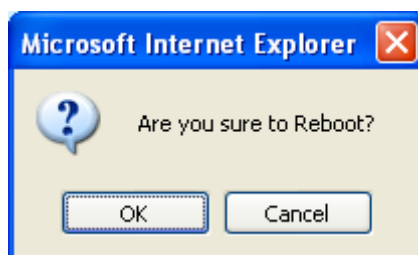

Figure 4-51 Reboot screen

4.14.2 Factory Reset

The Factory Reset button can reset the GSW-1602SF/GSW-2404SF/GSW-2416SF back to the factory default mode. Be aware that the entire configuration will be reset; expect the IP address of the GSW-1602SF/GSW-2404SF/GSW-2416SF. Once the Factory Reset item is pressed, the screen in Figure 4-52 appears.



Figure 4-52 Factory Reset screen

Note: To reset the IP address to the default IP Address “192.168.0.100”. Press the hardware reset button at the front panel about 5 seconds. After the device be rebooted. You can login the management WEB interface within the same subnet of 192.168.0.xx.

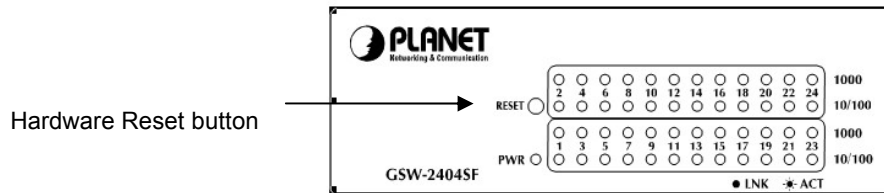

4.14.3 Firmware Upgrade

The **Firmware Upgrade** page contains fields for downloading system image files from the Local File browser to the device.

To open **Firmware Upgrade** screen perform the following:

1. Click **Tools -> Firmware Upgrade**
2. The Firmware Upgrade screen is displayed as in Figure 4-53.
3. Click the **"Browse"** button of the main page, the system would pop up the file selection menu to choose firmware.
4. Select on the firmware then click **"Upload"**, the **Software Upload Progress** would show the file upload status.

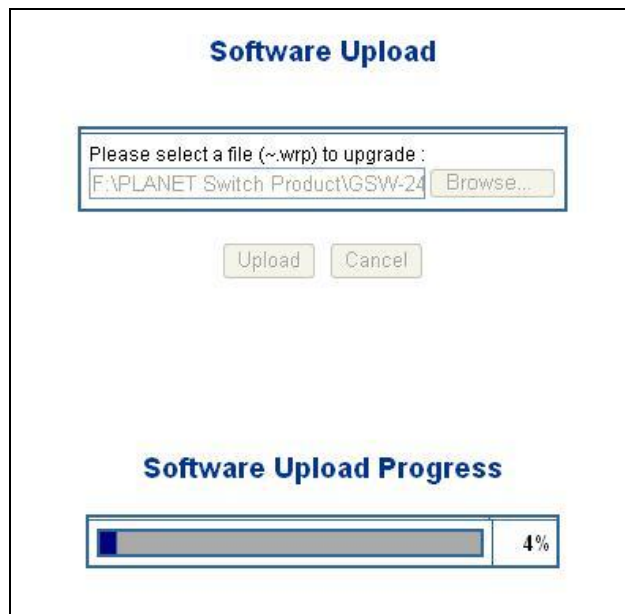

Figure 4-53 Firmware Upgrade screen

5. Once the software be loaded to the system successfully. The following screen appears. Click the **"Yes"** button to activate the new software immediately. The system will load the new software after reboot.

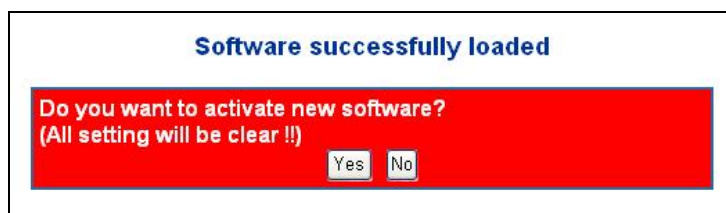



Figure 4-54 Software successfully loaded notice screen

 **Note:** Does not power off the Switch until the update progress is complete?

 **Note:** Do not quit the Firmware Upgrade page without press the “**Yes**” button - after the image is loaded. Or the system won’t apply the new firmware. The user have to repeat the firmware upgrade processes again.

4.14.4 Configuration Upload

This function allows backup and reload the current configuration of GSW-1602SF /2404SF/GSW-2416SF to the local management station. The screen in Figure 4-55 appears.

- **Configuration Upload:** Upload the existed configuration file to the GSW-1602SF/GSW-2404SF/GSW-2416SF. The configuration file had been saved at the local machine already.
- **Configuration Download:** Download the current configuration file of the switch to the local machine.



Figure 4-55 Configuration Upload/Download screen

■ Configuration Upload

1. Click the “**Browse**” button of the main page, the system would pop up the file selection menu to choose saved configuration.

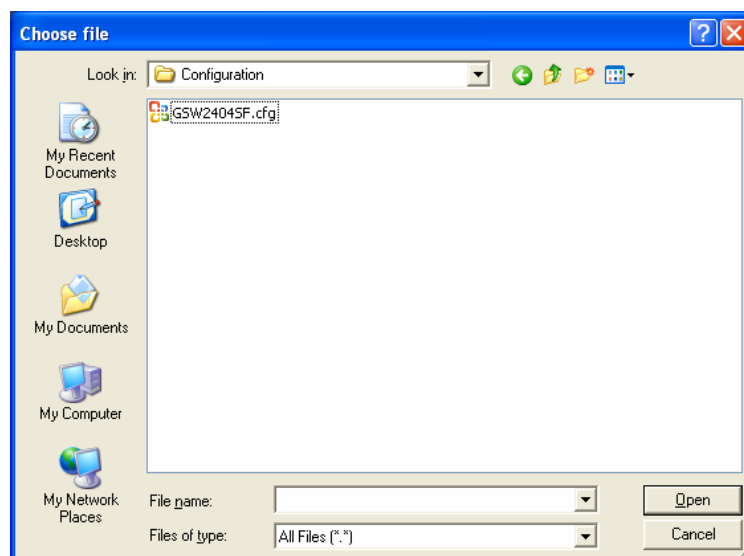

Figure 4-56 Windows file selection menu popup

2. Select on the configuration file then click “**Upload**”, the bottom of the browser shows the upload status.
3. After down, the main screen appears “**Transfer Completed**”.

■ **Configuration Download**

1. Press the “**Download**” button to save the current configuration in manager workstation. The following screens in Figure 4-57 and 4-58 appears.

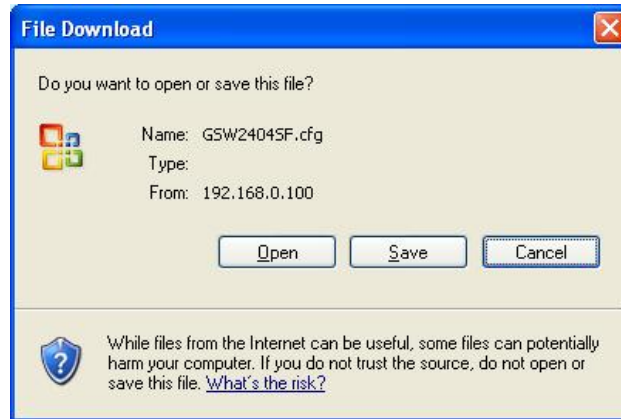

Figure 4-57 File Download screen

2. Chose the file save path in management workstation.

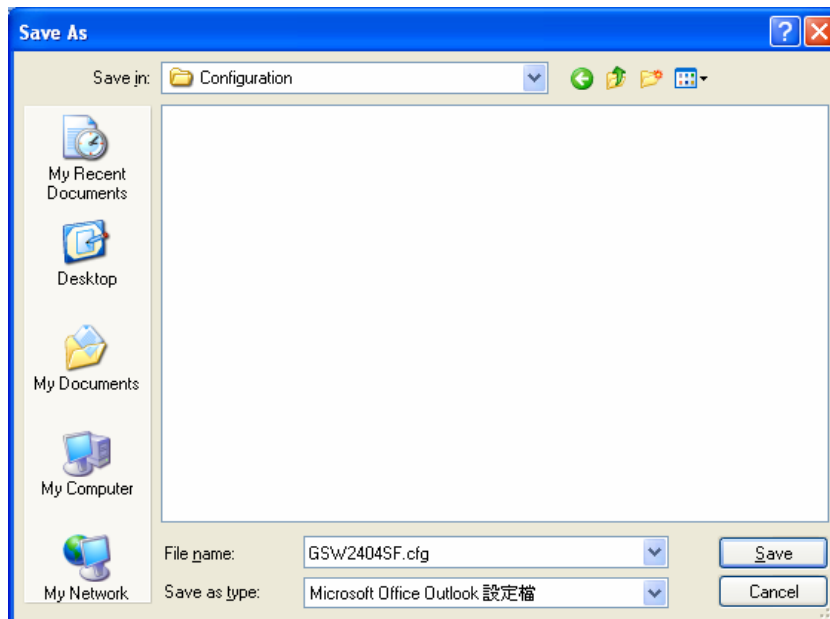

Figure 4-58 File save screen

4.14.5 Ping

Use this screen to tell the switch to send a Ping request to a specified IP address. You can use this to check whether the switch can communicate with a particular IP station. Once you click the Apply button, the switch will send *n* pings and the results will be displayed below the configurable data.

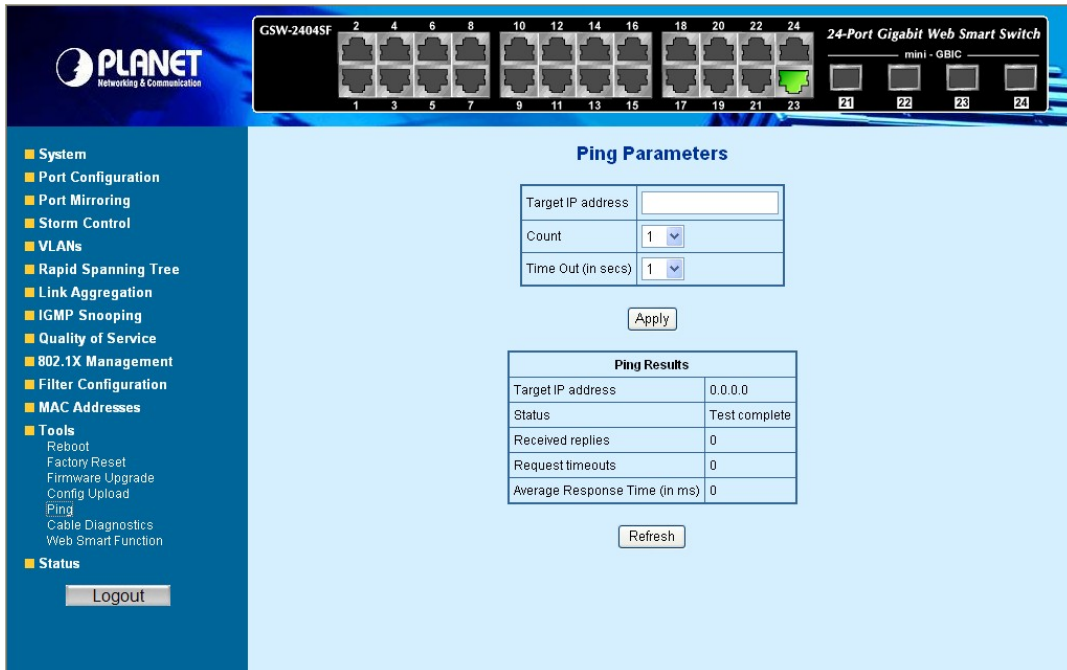

Figure 4-59 Ping function screen

The Ping Parameters includes the following fields: Table 4-29 Description of the Ping Parameters.

Item	Description
Target IP Address	Enter the IP address of the station you want the switch to ping. The initial value is blank. The IP Address you enter is not retained across a power cycle.
Count	Number of echo requests to send
Time Out (in secs)	Timeout in milliseconds to wait for each reply.

Table 4-29 Description of the Ping Parameters

After field the parameter and press “**Apply**” to execute the Ping function. The Ping result shows at the next table. As the Figure 4-60 screen appears.

Ping Results	
Target IP address	192.168.0.51
Status	Test complete
Received replies	10
Request timeouts	0
Average Response Time (in ms)	8

Refresh

Figure 4-60 Ping Result screen



Note: Be sure the target IP Address is within the same network subnet of the switch, or you had setup the correct gateway IP address.

4.14.6 Cable Diagnostics

The Cable Diagnostics page contains fields for performing tests on copper cables. These functions have the ability to identify the cable length and operating conditions, and to isolate a variety of common faults that can occur on the Cat5 twisted-pair cabling. There might be two statuses as follow:

- If the link is established on the twisted-pair interface in 1000BASE-T mode, the Cable Diagnostics can run without disruption of the link or of any data transfer.
- If the link is established in 100BASE-TX or 10BASE-T, the Cable Diagnostics cause the link to drop while the diagnostics are running.

After the diagnostics are finished, the link is reestablished. And the following functions are available.

- Coupling between cable pairs.
- Cable pair termination
- Cable Length

Anomalous coupling between cable pairs can be caused by shorted wires, improper termination, or high crosstalk resulting from an incorrect wire map. These conditions can all prevent the PLANET switch from establishing a link. The screen in Figure 4-61 appears.

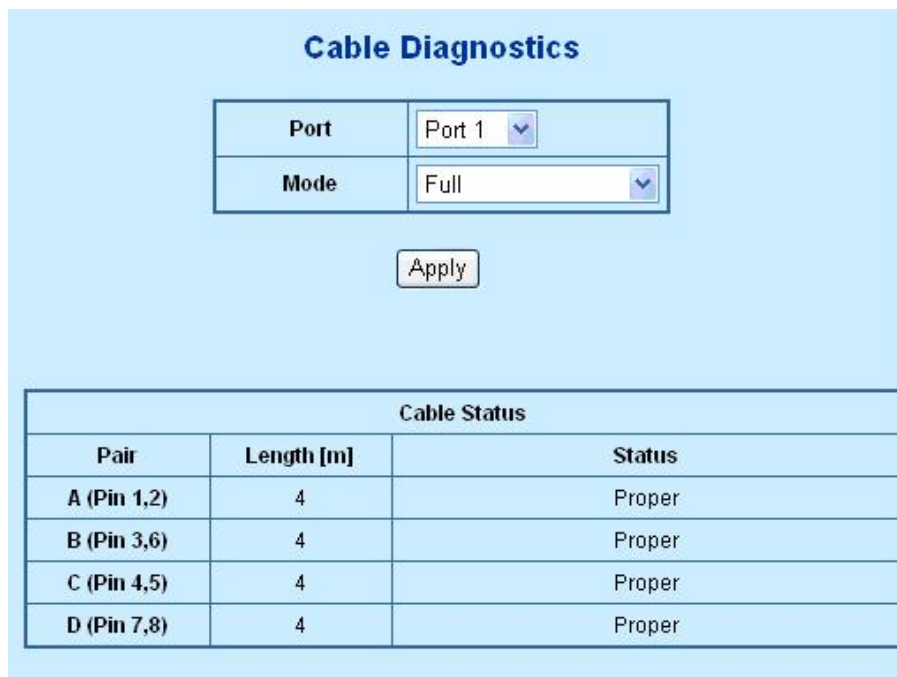

Figure 4-61 Cable Diagnostics

The Cable Diagnostics includes the following fields: Table 4-30 Description of the Cable Diagnostics.

• Item	Description
• Port	Specifies the port numbers for which to run the cable diagnostics.
• Mode	There're three cable test mode for selection: Full – test full pairs Anomaly – test with only anomaly pairs Anomaly w/o X-pair - test anomaly pairs but without X-pair

Table 4-30 Description of the Cable Diagnostics

The Cable status includes the following items: Table 4-31 Description of the Cable Status.

• Item	Description
• Pair	The twist pair of the UTP cable. The pair groups as follow: A (Pin 1,2) B (Pin 3,6) C (Pin 4,5) D (Pin 7,8)
• Length[m]	When properly terminated, Cable Diagnostics reports the approximate cable length in meters of each of the four cable pair A, B, C, and D.
• Status	The cable test results. Possible values are: <ul style="list-style-type: none"> • Proper - The cable passed the test. • Open - The cable is connected on only one side or there is no cable connected to the port • Short - A short has occurred in the cable. With 10/100BASE link, the status of Pair C and Pair D will be “Short”. • Abnormal termination – An improper termination be detected. Proper termination of Cat5 cable requires 100Ω differential impedance between the positive and negative cable terminals. IEEE STD 802.3 allows for a termination of as large as 115Ω or as small as 85Ω. If the termination falls out of this range, it is reported as falls an anomalous termination.

Table 4-31 Description of the Cable Status



Note:

Be sure to running the Cable diagnostics with standard Cat 5e or Cat 6 UTP cable. With some of the UTP cables that not match the standard of Cat 5e, it might cause the 10/100Base-TX link down after the cable diagnostics.

4.14.7 Web Smart Function

This function could provide you to define device indicate connect to each port on Web Smart Switch, the screen in Figure 4-62 appears.

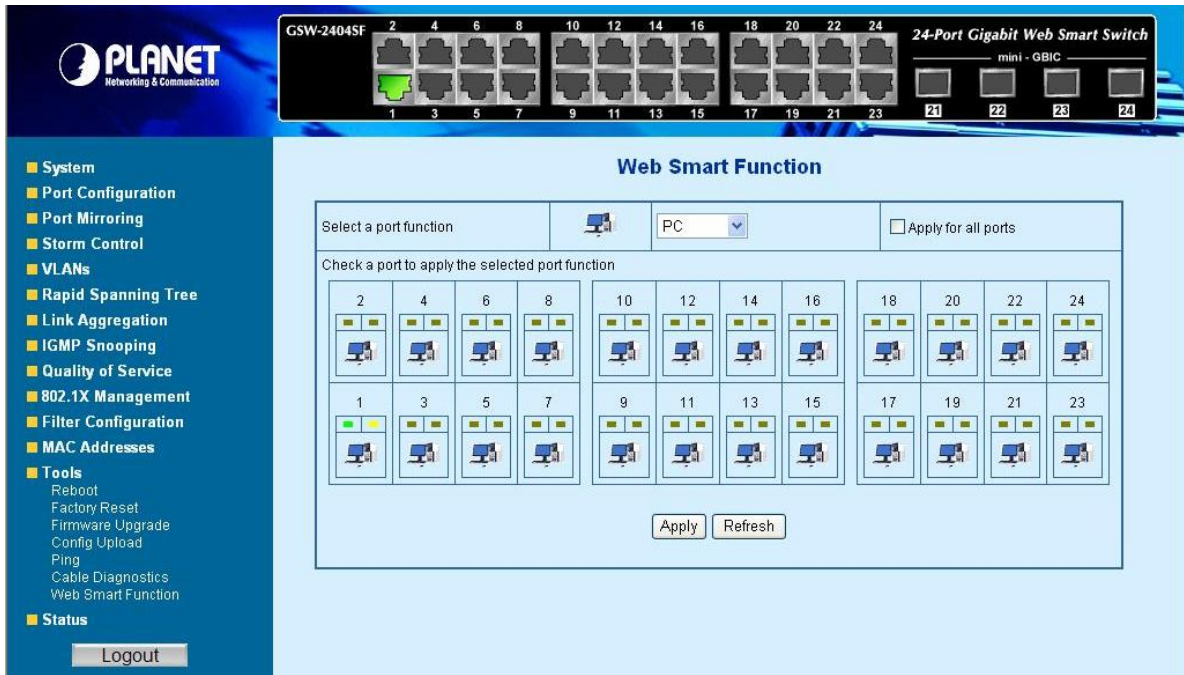









Figure 4-62 Web Smart Function Web Page screen

The available options are shown as below: Table 4-32 Description of the Web smart function.

Item	Description
• PC	
• PC+Voip	
• Switch	
• Router	
• AP	
• Server	
• Printer	
• Guest	

• Other	Other
---------	-------

Table 4-32 Description of the Web smart function

Assign an icon to specific port

1. Choose a device icon from options of **Select a port function**.
2. Check the **port** that need to marked.
3. After setup completed, press **“Save”** to save current configuration.
4. Please press **“Back”** for return to Web Smart Function screen.

■ Assign an icon to all ports

1. Choose a device icon from options of **Select a port function**.
2. Check the box **“Apply to all ports”**.
3. Move the cursor to the any port and click, all the icons be changed.
4. After setup completed, press **“Save”** to save current configuration.
5. Please press **“Back”** for return to Web Smart Function screen.

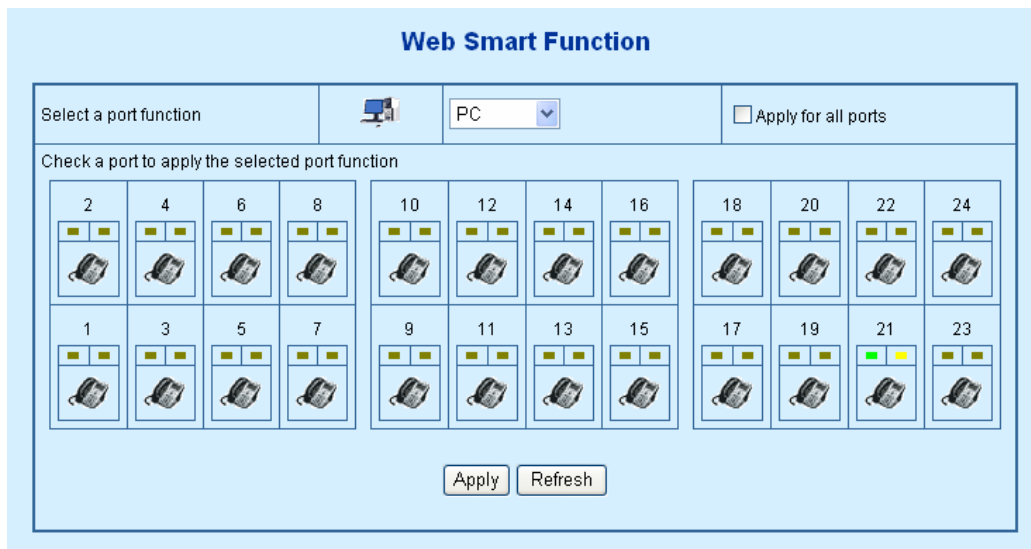

Figure 4-63 Web Smart Function – Apply to all ports

4.15 Status

Click on the “Status” to present the Switch status on this screen, it displays the following status:

- Port Statistics
- LACP Status
- RSTP Status
- IGMP Snooping Status
- Multicast Group Table

4.14.1 Port Statistics

The Port Statistic page displays the status of packet count from each port. The Port statistics screen in Figure 4-64 appears.

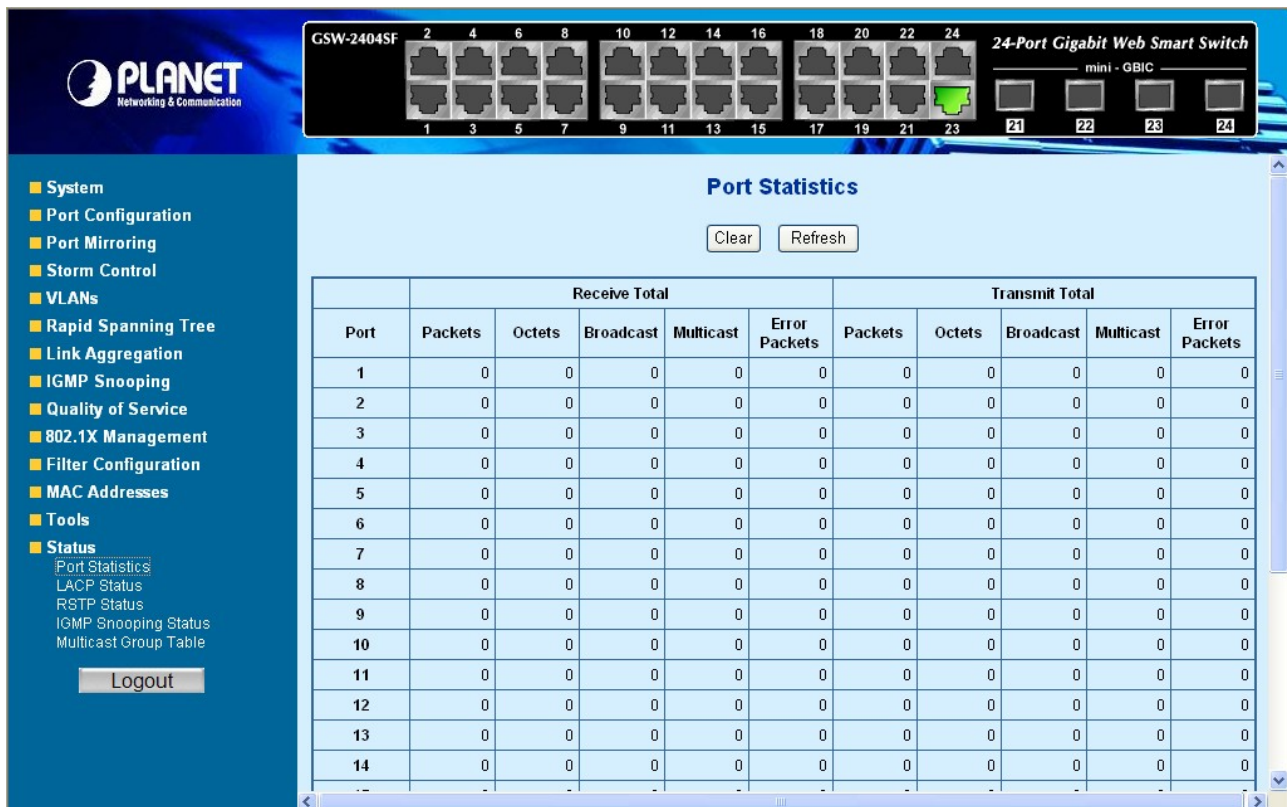

Figure 4-64 Port Statistics screen

The page includes the following fields: Table 4-33 Description of the Port Statistics.

Item	Description
Port ID	The Port number. Press the port ID for detail packet information on the selected port.
Receive Packets	Number of total packets received on the selected port. Include the Unicast, broadcast and multicast packets.
Receive Octets	Number of total octets of data (including those in bad packets) received on the selected port.
Receive Broadcast	Number of Broadcast packets received on the selected port.

• Receive Multicast	Number of Multicast packets received on the selected port.
• Receive Broad and Multicast	Subtotal number of Broadcast and Multicast packets received on the selected port.
• Receive Errors Packets	The number of error packets received on the selected port.
• Transmit Packets	Number of total packets transmitted from the selected port. Include the Unicast , broadcast and multicast packets.
• Transmit Octets	Number of total octets of data (including those in bad packets) transmitted from the selected port.
• Transmit Broadcast	Number of Broadcast packets transmitted from the selected port.
• Transmit Multicast	Number of Multicast packets transmitted from the selected port.
• Transmit Broad and Multicast	Subtotal number of Broadcast and Multicast packets transmitted from the selected port.
• Transmit Errors Packets	The number of error packets transmitted from the selected port.

Table 4-33 Description of the Port Statistics

4.15.2 LACP Status

The LACP Status page display the current LACP aggregation Groups and LACP Port status.

Please refer to [Chapter 4.8.3](#) at page-42 for more detail.

4.15.3 RSTP Status

The RSTP Status page display the current STP bridge , roor bridge and per port stp status.

Please refer to [Chapter 4.7.3](#) at page-35 for more detail.

4.15.4 IGMP Snooping Status

The IGMP Snooping page display the current IGMP Status and the statistics of received Query / report packets.

Please refer to [Chapter 4.9.2](#) at page-46 for more detail.

4.15.5 Multicast Group Status

The Multicast Group page displays the ports attached to the Multicast service group in the Ports tables. The Port a tables also reflect the manner in which the port joined the Multicast group. Ports can be added either to existing groups or to new Multicast service groups. The Bridge Multicast Group page permits new Multicast service groups to be created. The Bridge Multicast Group page also assigns ports to a specific Multicast service address group.

Please refer to [Chapter 4.9.3](#) at page-48 for more detail

Logout

Press this function; the web interface will go back to login screen. The screen in Figure 4-65 & 4-66 appears.

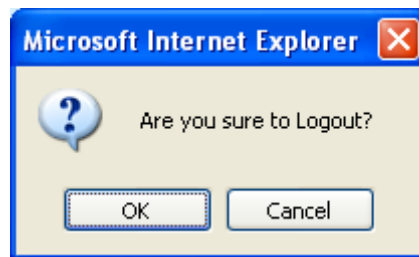

Figure 4-65 Logout screen



Figure 4-66 Login screen

5. SWITCH OPERATION

5.1 Address Table

The Switch is implemented with an address table. This address table composed of many entries. Each entry is used to store the address information of some node in network, including MAC address, port no, etc. This information comes from the learning process of Ethernet Switch.

5.2 Learning

When one packet comes in from any port, the Switch will record the source address, port no. And the other related information in address table. This information will be used to decide either forwarding or filtering for future packets.

5.3 Forwarding & Filtering

When one packet comes from some port of the Ethernet Switching, it will also check the destination address besides the source address learning. The Ethernet Switching will lookup the address-table for the destination address. If not found, this packet will be forwarded to all the other ports except the port, which this packet comes in. And these ports will transmit this packet to the network it connected. If found, and the destination address is located at different port from this packet comes in, the Ethernet Switching will forward this packet to the port where this destination address is located according to the information from address table. But, if the destination address is located at the same port with this packet comes in, then this packet will be filtered. There by increasing the network throughput and availability.

5.4 Store-and-Forward

Store-and-Forward is one type of packet-forwarding techniques. A Store-and-Forward Ethernet Switching stores the incoming frame in an internal buffer, do the complete error checking before transmission. Therefore, no error packets occurrence, it is the best choice when a network needs efficiency and stability.

The Ethernet Switch scans the destination address from the packet-header, searches the routing table provided for the incoming port and forwards the packet, only if required. The fast forwarding makes the switch attractive for connecting servers directly to the network, thereby increasing throughput and availability. However, the switch is most commonly used to segment existing hubs, which nearly always improves overall performance. An Ethernet Switching can be easily configured in any Ethernet network environment to significantly boost bandwidth using conventional cabling and adapters.

Due to the learning function of the Ethernet switching, the source address and corresponding port number of each incoming and outgoing packet are stored in a routing table. This information is subsequently used to filter packets whose destination address is on the same segment as the source address. This confines network traffic to its respective domain, reducing the overall load on the network.

The Switch performs "Store and forward" therefore, no error packets occur. More reliably, it reduces the re-transmission rate. No packet loss will occur.

5.5 Auto-Negotiation

The STP ports on the Switch have built-in "Auto-negotiation". This technology automatically sets the best possible bandwidth when a connection is established with another network device (usually at Power On or Reset). This is done by detect the modes and speeds at the second of both device is connected and capable of, both 10Base-T and 100Base-TX devices can connect with the port in either Half- or Full-Duplex mode. 1000Base-T can be only connected in Full-duplex mode.

5.6 IGMP Snooping

Theory

Computers and network devices that want to receive multicast transmissions need to inform nearby routers that they will become members of a multicast group. The Internet Group Management Protocol (IGMP) is used to communicate this information. IGMP is also used to periodically check the multicast group for members that are no longer active. In the case where there is more than one multicast router on a sub network, one router is elected as the 'queried'. This router then keeps track of the membership of the multicast groups that have active members. The information received from IGMP is then used to determine if multicast packets should be forwarded to a given sub network or not. The router can check, using IGMP, to see if there is at least one member of a multicast group on a given sub network. If there are no members on a sub network, packets will not be forwarded to that sub network.

IGMP Versions 1 and 2

Multicast groups allow members to join or leave at any time. IGMP provides the method for members and multicast routers to communicate when joining or leaving a multicast group.

IGMP version 1 is defined in RFC 1112. It has a fixed packet size and no optional data.

The format of an IGMP packet is shown below:

IGMP Message Format

Octets

0	8	16	31
Type	Response Time	Checksum	
Group Address (all zeros if this is a query)			

The IGMP Type codes are shown below:

Type Meaning

- 0x11** Membership Query (if Group Address is 0.0.0.0)
- 0x11** Specific Group Membership Query (if Group Address is Present)
- 0x16** Membership Report (version 2)
- 0x17** Leave a Group (version 2)
- 0x12** Membership Report (version 1)

IGMP packets enable multicast routers to keep track of the membership of multicast groups, on their respective sub networks. The following outlines what is communicated between a multicast router and a multicast group member using IGMP.

A host sends an IGMP "**report**" to join a group

A host will never send a report when it wants to leave a group (for version 1).

A host will send a "**leave**" report when it wants to leave a group (for version 2).

Multicast routers send IGMP queries (to the all-hosts group address: 224.0.0.1) periodically to see whether any group members exist on their sub networks. If there is no response from a particular group, the router assumes that there are no group members on the network.

The Time-to-Live (TTL) field of query messages is set to 1 so that the queries will not be forwarded to other sub networks.

IGMP version 2 introduces some enhancements such as a method to elect a multicast queried for each LAN, an explicit leave message, and query messages that are specific to a given group.

The states a computer will go through to join or to leave a multicast group are shown below:

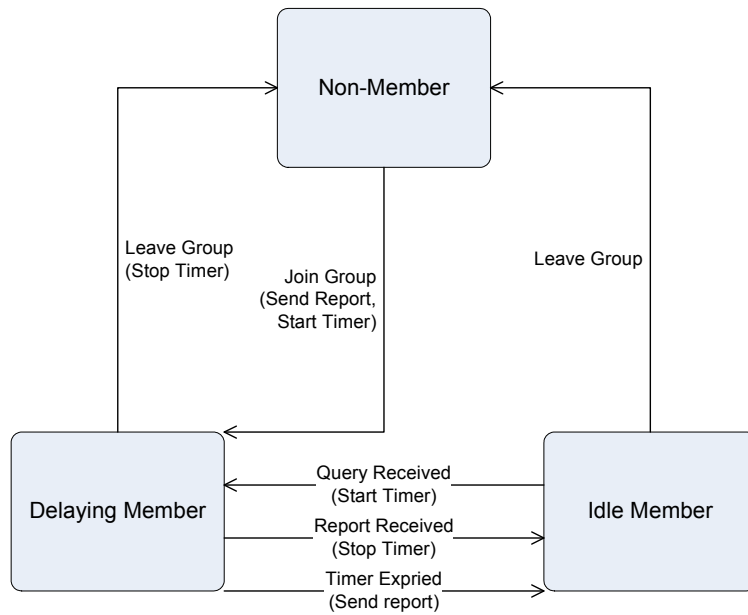

IGMP State Transitions

6. TROUBLESHOOTING

This chapter contains information to help you solve problems. If the Switch is not functioning properly, make sure the Ethernet Switch was set up according to instructions in this manual.

The Link LED is not lit

Solution:

Check the cable connection and remove duplex mode of the Switch.

Some stations cannot talk to other stations located on the other port

Solution:

Please check the VLAN, port trunking function that may introduce this kind of problem.

Performance is bad

Solution:

Check the full duplex status of the Ethernet Switch. If the Ethernet Switch is set to full duplex and the partner is set to half duplex, then the performance will be poor.

100Base-TX port link LED is lit, but the traffic is irregular

Solution:

Check that the attached device is not set to dedicate full duplex. Some devices use a physical or software switch to change duplex modes. Auto-negotiation may not recognize this type of full-duplex setting.

Why the Switch doesn't connect to the network

Solution:

Check the LNK/ACT LED on the Switch .Try another port on the Switch. Make sure the cable is installed properly
Make sure the cable is the right type Turn off the power. After a while, turn on power again.

APPENDIX A

A.1 Switch's RJ-45 Pin Assignments

1000Mbps, 1000Base T

Contact	MDI	MDI-X
1	BI_DA+	BI_DB+
2	BI_DA-	BI_DB-
3	BI_DB+	BI_DA+
4	BI_DC+	BI_DD+
5	BI_DC-	BI_DD-
6	BI_DB-	BI_DA-
7	BI_DD+	BI_DC+
8	BI_DD-	BI_DC-

Implicit implementation of the crossover function within a twisted-pair cable, or at a wiring panel, while not expressly forbidden, is beyond the scope of this standard.

A.2 10/100Mbps, 10/100Base-TX

Contact	MDI	MDI-X
1	1	3
2	2	6
3	3	1
6	6	2

A.3 RJ-45 cable pin assignment

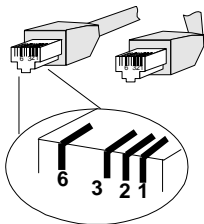

There are 8 wires on a standard UTP/STP cable and each wire is color-coded. The following shows the pin allocation and color of straight cable and crossover cable connection:

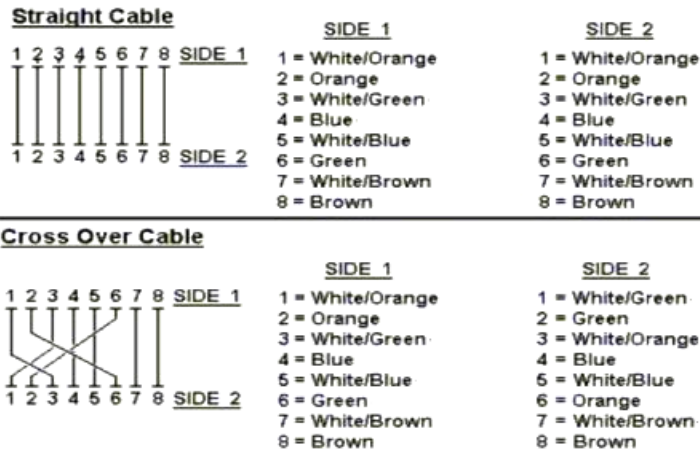

Figure A-1: Straight-Through and Crossover Cable

Please make sure your connected cables are with same pin assignment and color as above picture before deploying the cables into your network.

A.4 Available Modules

The following list the available Modules for GSW-1602SF / GSW-2404SF / GSW-2416SF.

MGB-GT	SFP-port 1000Base-T Module
MGB-SX	SFP-port 1000Base-SX mini-GBIC module
MGB-LX	SFP-port 1000Base-LX mini-GBIC module
MGB-L50	SFP-port 1000Base-LX mini-GBIC module-50KM
MGB-L70	SFP-port 1000Base-LX mini-GBIC module-70KM
MGB-L120	SFP-port 1000Base-LX mini-GBIC module-120KM
MGB-LA10	SFP-port 1000Base-LX(WDM,TX:1310nm) mini-GBIC module-10KM
MGB-LB10	SFP-port 1000Base-LX (WDM,TX:1550nm) mini-GBIC module-10KM
MGB-LA20	SFP-port 1000Base-LX(WDM,TX:1310nm) mini-GBIC module-20KM
MGB-LB20	SFP-port 1000Base-LX (WDM,TX:1550nm) mini-GBIC module-20KM
MGB-LA40	SFP-port 1000Base-LX(WDM,TX:1310nm) mini-GBIC module-40KM
MGB-LB40	SFP-port 1000Base-LX (WDM,TX:1550nm) mini-GBIC module-40KM